

6

**Anschluß Steckdose / Connection de la prise / Socket connection / Contactdoos aansluiting**

DIN/ISO 11446		D	F	GB	NL	Pmax
	1/L	gelb	jaune	yellow	geel	21W
	2	blau	bleu	blue	blauw	2x21W
	2a	grau	gris	grey	grijs	
	3/31	weiß	blanc	white	wit	
	4/R	grün	vert	green	groen	21W
	5/58-R	braun	marron	brown	bruin	52W
	6/54	rot	rouge	red	rood	3x21W
	7/58-L	schwarz	noir	black	zwart	52W
	8	schwarz/rot	noir/rouge	black/red	zwart/rood	2x21W
	9	braun/weiß	marron/blanc	brown/white	bruin/wit	180W / 15 Amp
	10	rot	rouge	red	rood	180W / 15 Amp
	11	weiß	blanc	white	wit	
	12	rot/blau	rouge/bleu	red/blue	rood/blauw	
	13	weiß	blanc	white	wit	

7

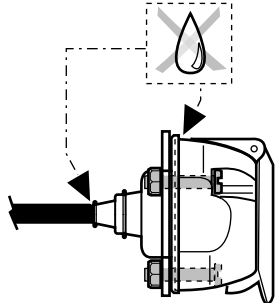
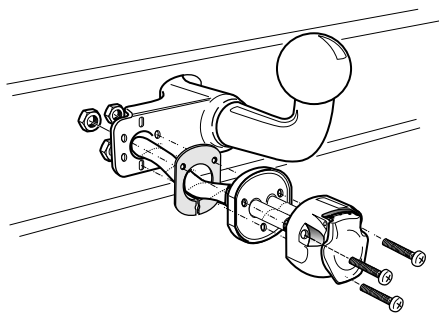
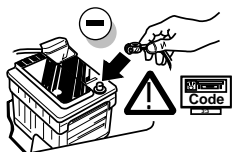

8

- D** FUNKTIONEN KONTROLLIEREN !  
**F** CONTRÔLER LES FONCTIONS !  
**GB** CHECK FUNCTIONS !  
**NL** CONTROLEER FUNCTIES !

9

- D** Zurück montieren Teile.  
**F** Montez les part enlevés.  
**GB** Reinstall linings.  
**NL** Terug plaatsen onderdelen.

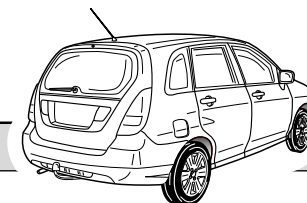
**SUZUKI LIANA 5dr 2002-  
 Nr.: SZ-013-DB 1**

\* Teilliste \* Liste de pieces \* Part list \* Onderdelenlijst

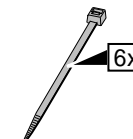
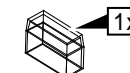
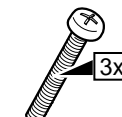
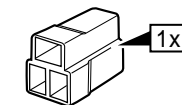
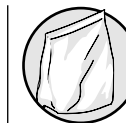
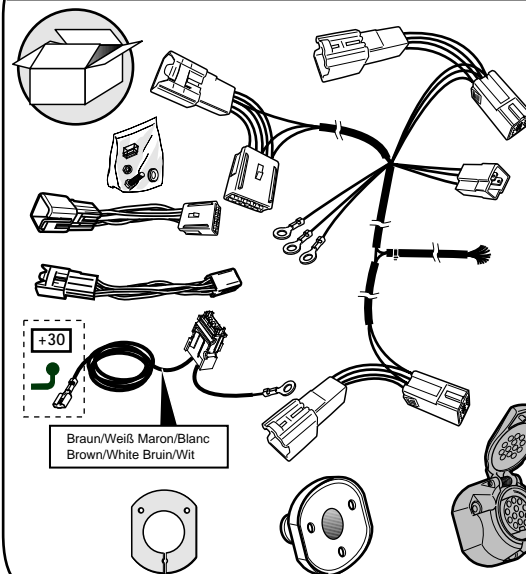

- D** Einbauanleitung Elektrosatz  
 Anhängervorrichtung mit 13-P Steckdose  
 lt. DIN/ISO Norm 11446
- F** Instructions de montage du faisceau  
 électrique pour crochet d'attelage  
 conforme à la norme  
 DIN/ISO 11446 prise 13-P

- GB** Fitting instructions electric wiringkit  
 towbar with 13-P socket up to  
 DIN/ISO norm 11446
- NL** Montage-handleiding elektrokabelset  
 voor trekhaak met 13-P contactdoos  
 vlg. DIN/ISO norm 11446



- D**
- Wir weisen ausdrücklich darauf hin, das eine unsachgemäße und nicht in einer Fachwerkstätte durchgeführte Montage einen Verzicht auf die Geltendmachung jeglicher Art insbesondere auch aus dem Titel des Produkthaftpflichtrechtes bewirkt.
  - Technische Änderungen vorbehalten.
  - Belastung nur tabellgemäß auf dem anhänger verwenden, siehe Seite 4.

- F**
- Il est expressement prévu qu' on ne saurait se prévaloir d'un quelconque préjudice contractuel ou réhibitoire si le montage avait été fait en dépit des dites instructions ou dans un garage ne disposant pas des équipements adéquats.
  - Sous réserve de modifications techniques.
  - Ne excédez pas la charge maximale, indiquée dans le tableau sur page 4.

- GB**
- We would expressly point out that any improper assembly which is not carried out in a specialist workshop will result in the renunciation of the enforcement of compensation claims of any kind, in particular those arising by virtue of the product liability law.
  - Subject to alteration without notice.
  - Only use maximum charge according to connectiontable on towed vehicle, see page 4.

- NL**
- Wij wijzen er met nadruk op, dat ondeskundige en niet door een vakkundige werkplaats uitgevoerde montage tot gevolg heeft dat daardoor ieder recht op schadevergoeding, ook op wettelijke aansprakelijkheid inzake producten, vervalt.
  - Technische wijzigingen voorbehouden.
  - Gebruik alleen belasting volgens aansluittabel op het getrokken voertuig, zie pagina 4.

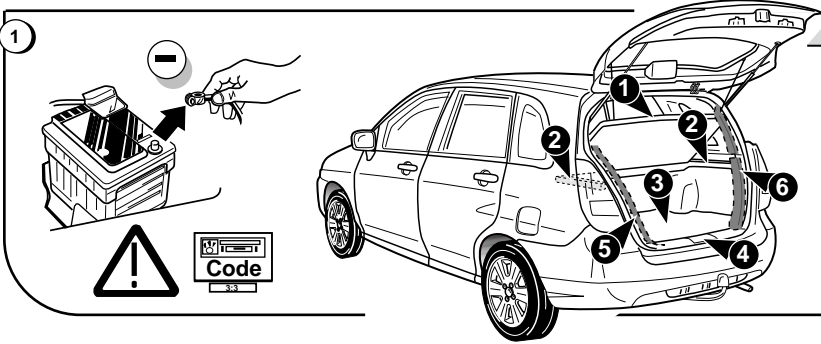

**D** Abmontieren Teile

**F** Démontez les parts

**GB** Remove linings

**NL** Verwijder onderdelen

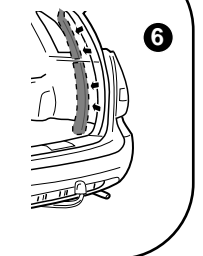
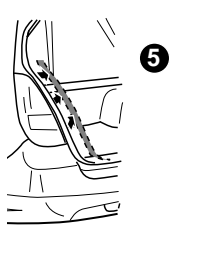
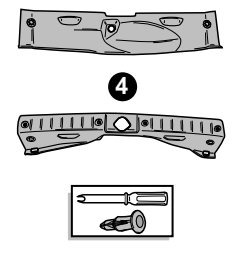
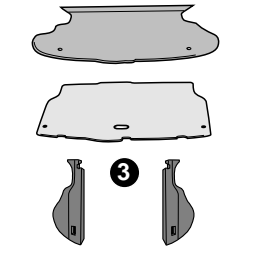
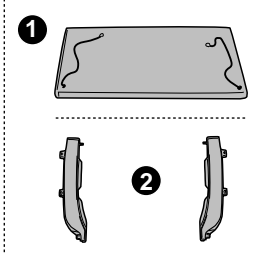

**INFO**

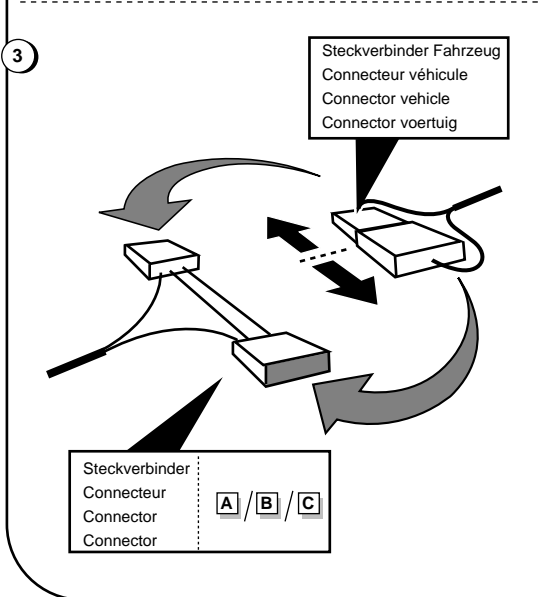
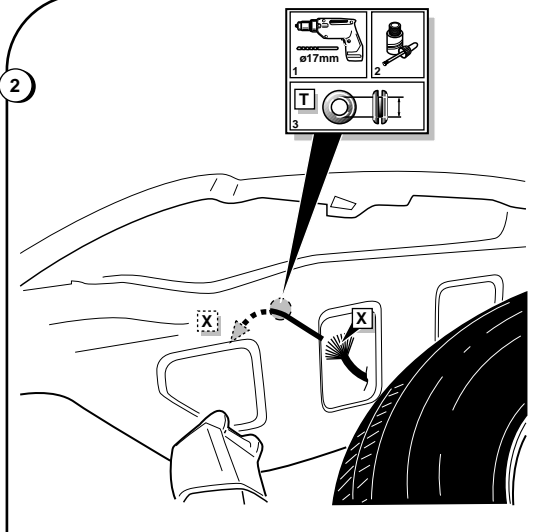
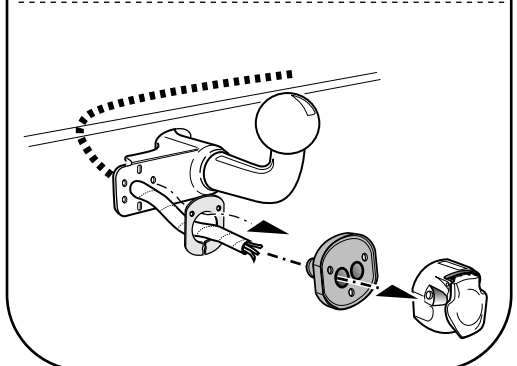
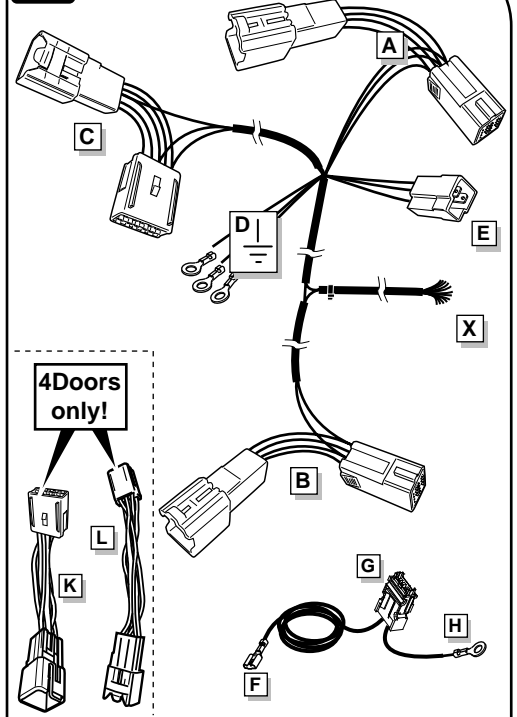

**ROUTING**

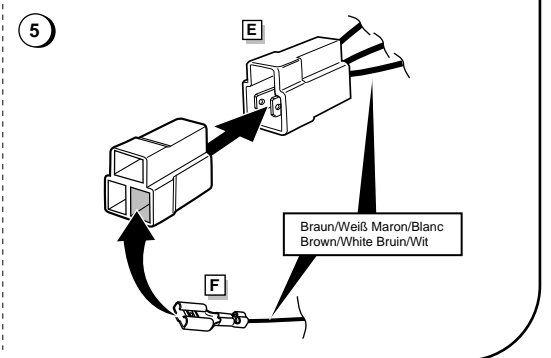
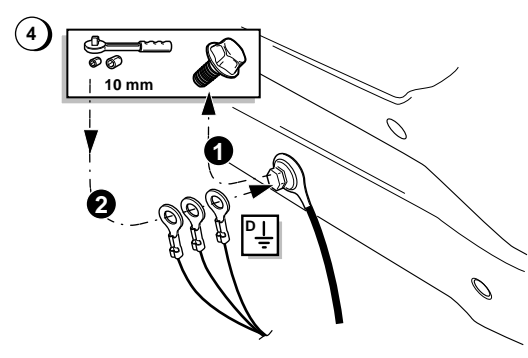
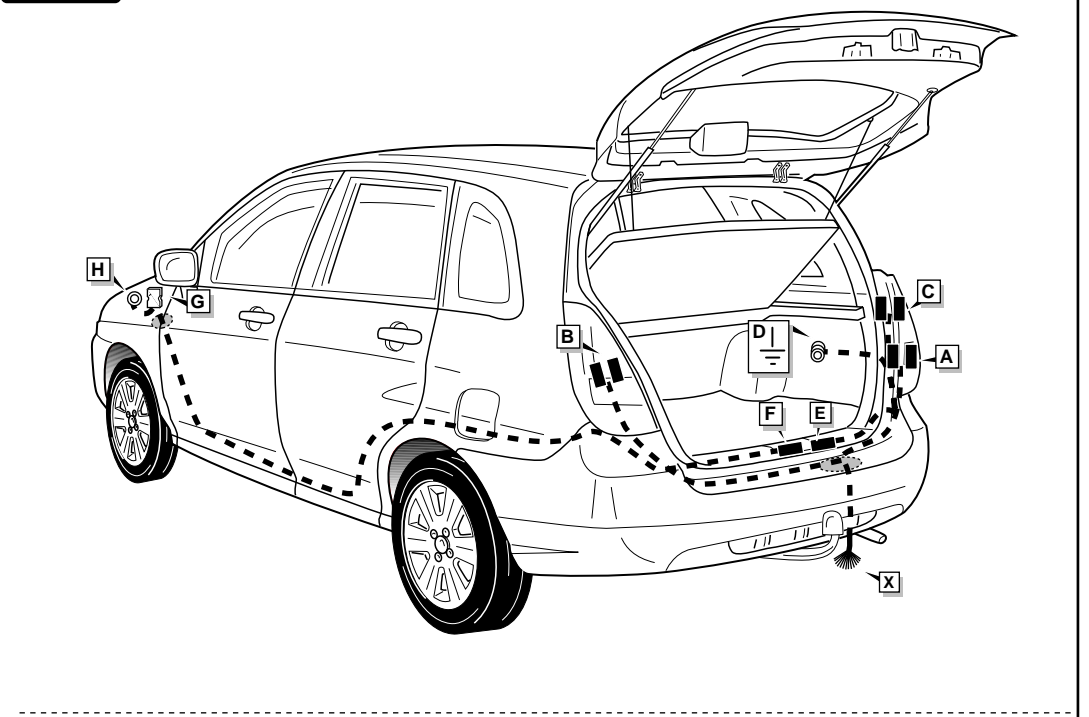



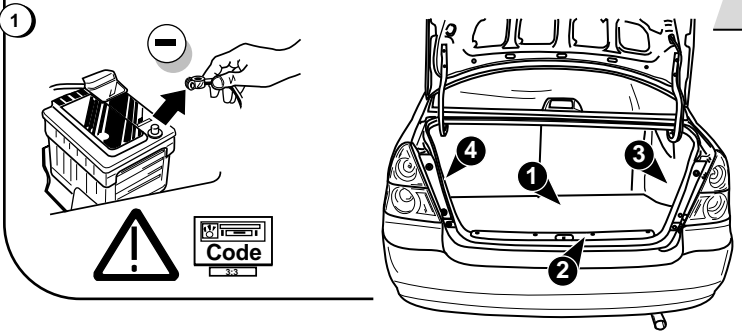

**D** Abmontieren Teile

**F** Démontez les parts

**GB** Remove linings

**NL** Verwijder onderdelen

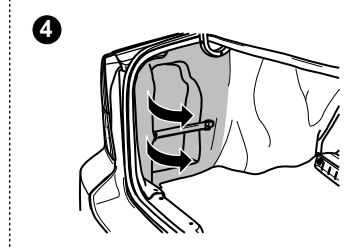
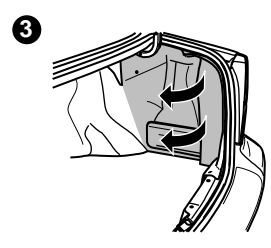
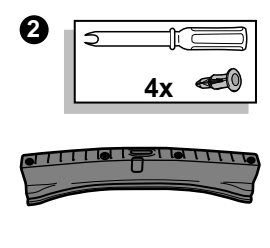
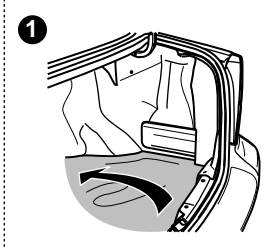

**INFO**

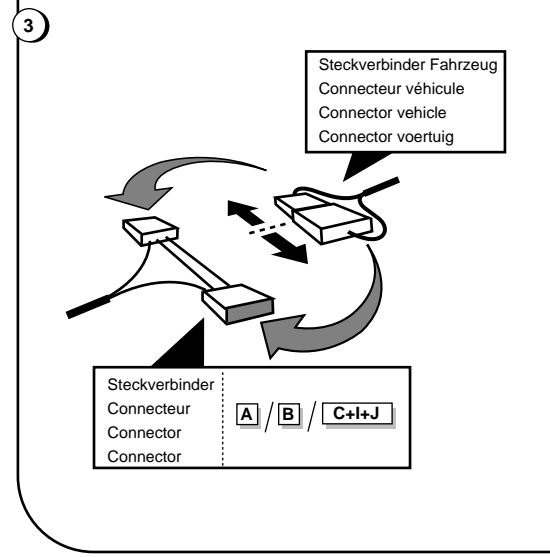
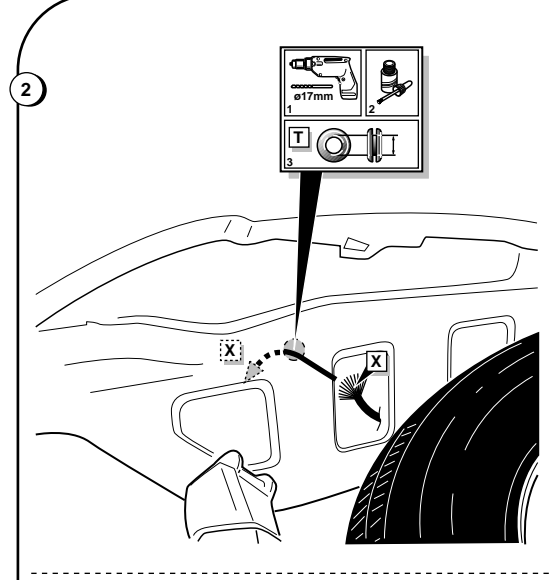
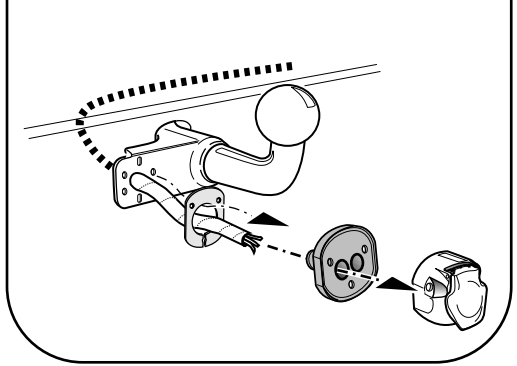
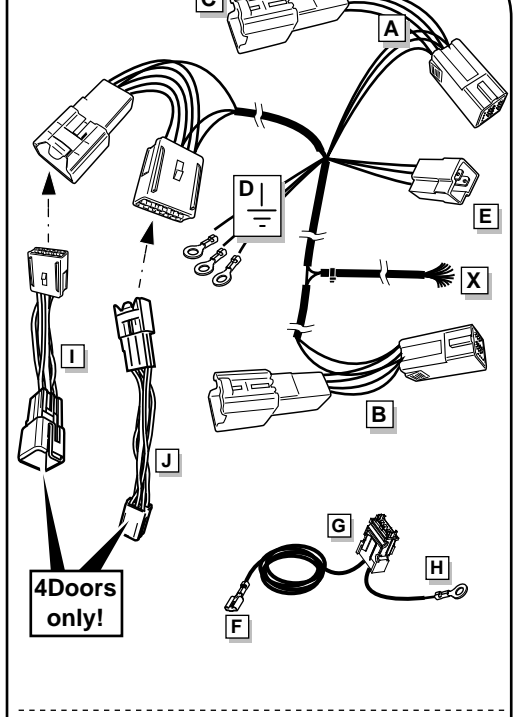

**ROUTING**

