

Ford C-MAX II **07/2010 >>**
Ford Focus Sedan **01/2011 >>**
Ford Focus Hatchback **01/2011 >>**

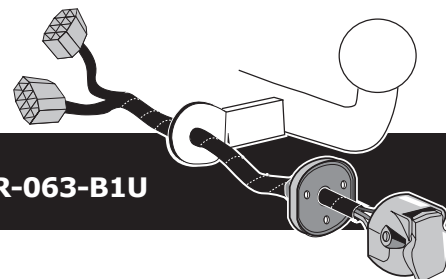

Partnr.: FR-063-B1U

- Fitting instructions electric wiring kit tow bar with 12-N socket up to DIN/ISO Norm 1724.
- We would expressly point out that assembly not carried out properly by a competent installer will result in cancellation of any right to damage compensation, in particular those arising by virtue of the product liability act.
- Contents of these kits and their fitting manuals are subject to alteration without notice, please ensure that these instructions are read and fully understood before commencing installation.
- Do not overload circuits; the maximum loads per connection are detailed in this manual.
- Attention! Before Installation, please read this manual carefully and inform your customer to consult the vehicle owners manual to check for any vehicle modifications required before towing.
- In the event of functional problems, troubleshooting must be limited to about 0.5 hours, contact the technical support:
ukts@ecs-electronics.com / 07440 202 052.



Part list

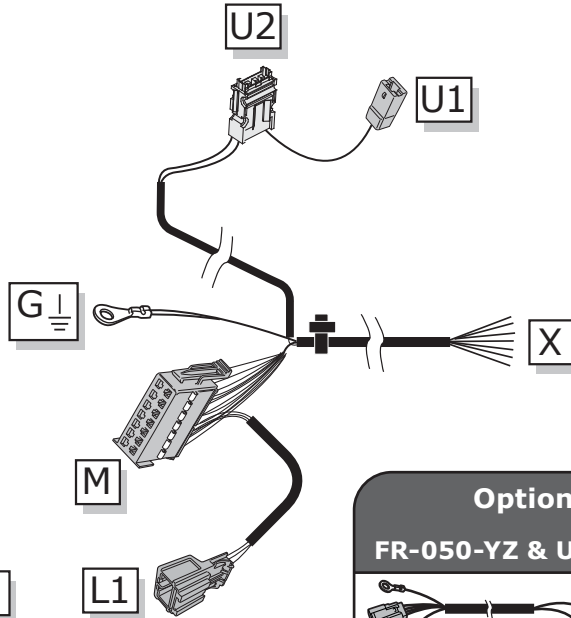
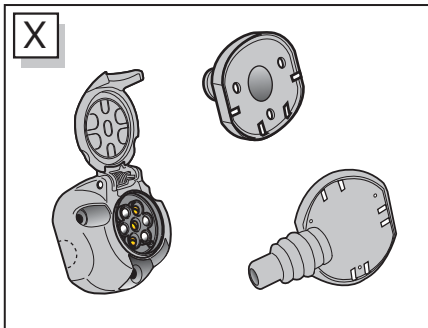
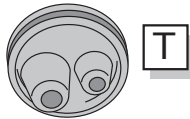
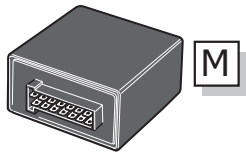
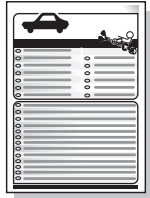
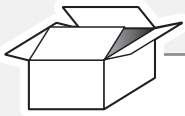

Optional
FR-050-YZ & UN-094-YZ

Pag. 14

UN-243-YZ
Optional reverse lamp
pre-wire extension included

Pag. 19

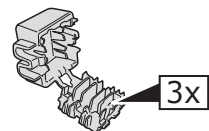
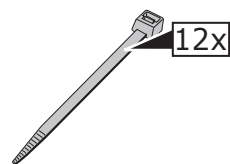
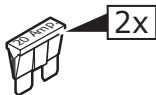
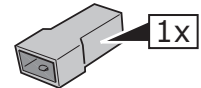
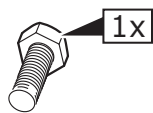
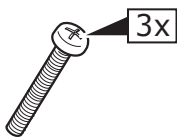

ROUTING

C-Max II

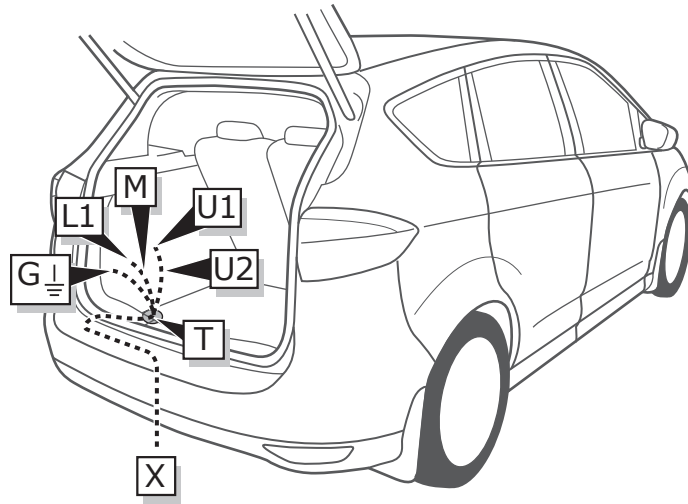

Focus Sedan

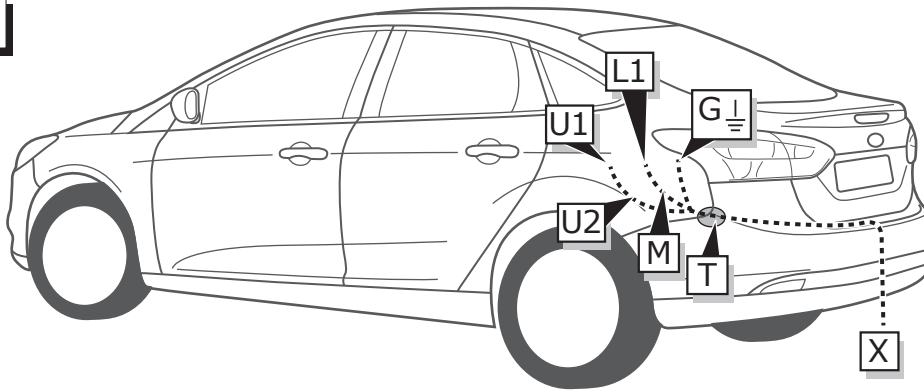

Focus Hatchback

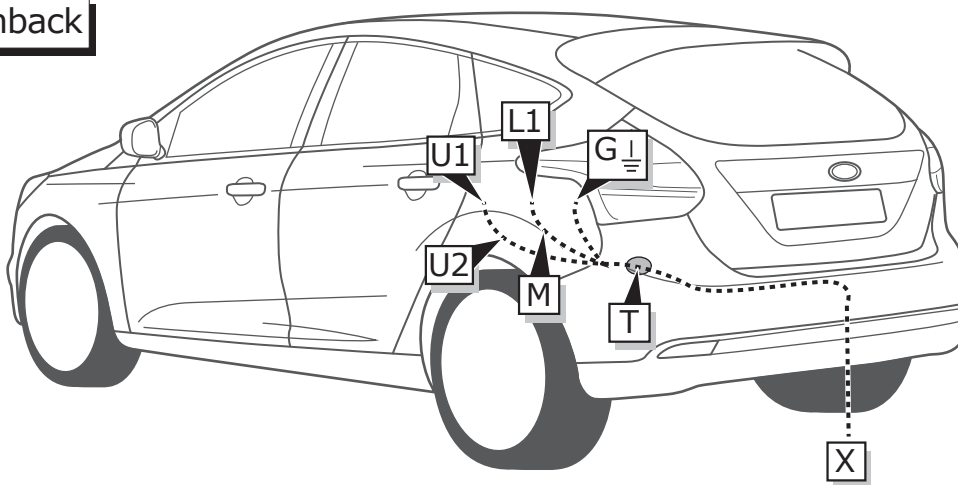

1

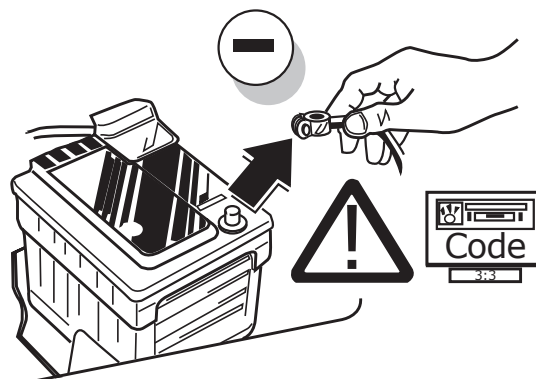

2

C-Max II

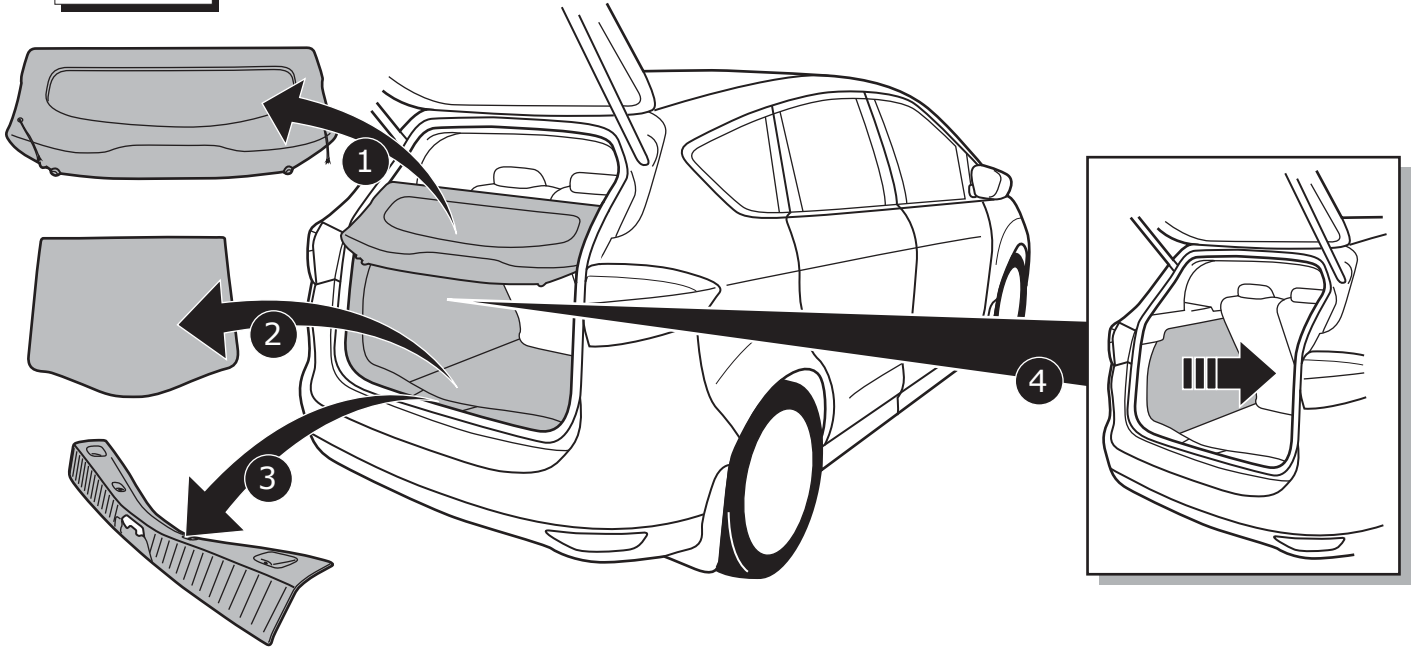

3

Focus Sedan

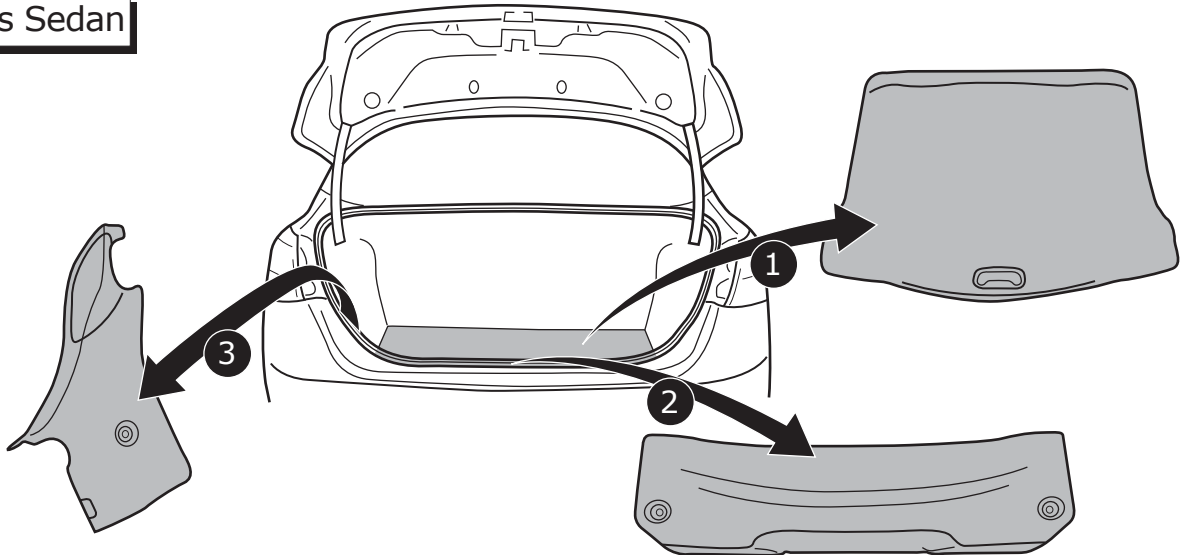

4

Focus Sedan

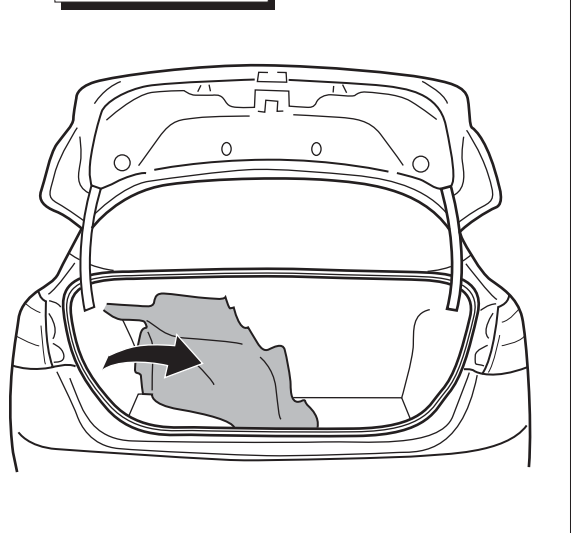

5

Focus Hatchback

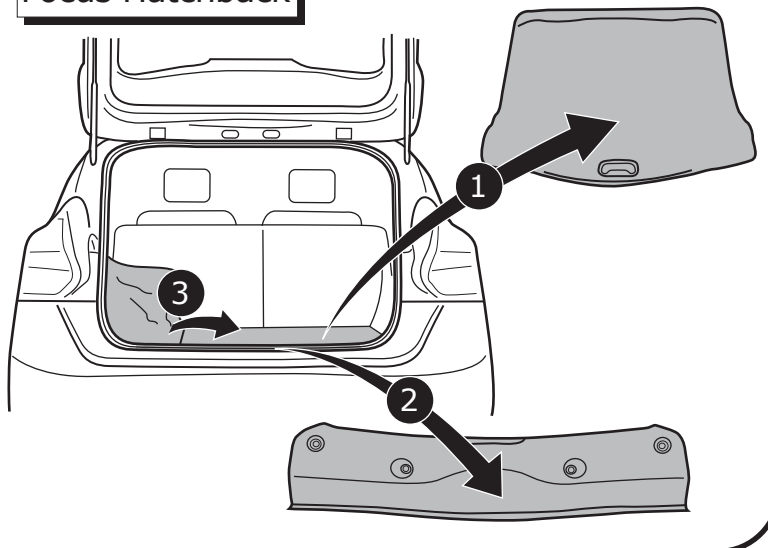

OPTION 1

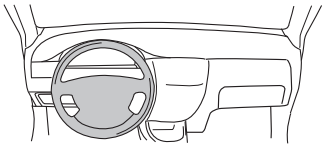

C-Max II LHD

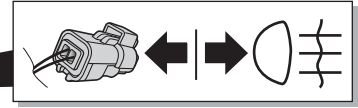
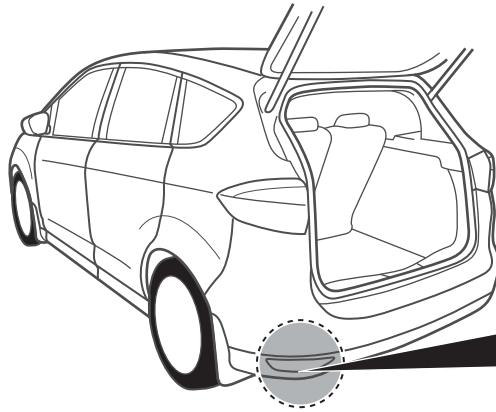

1

2

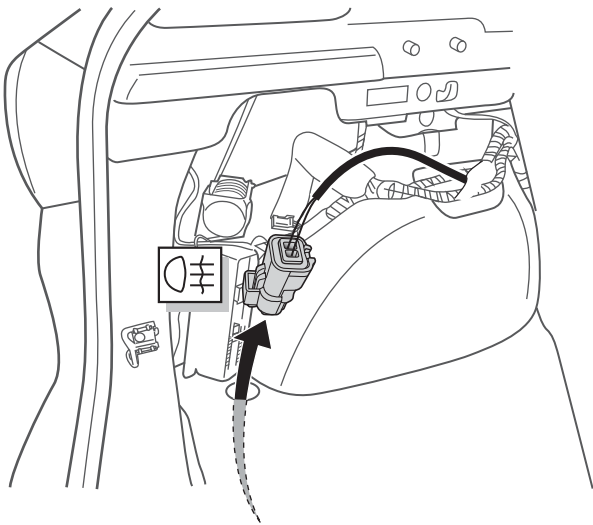

4

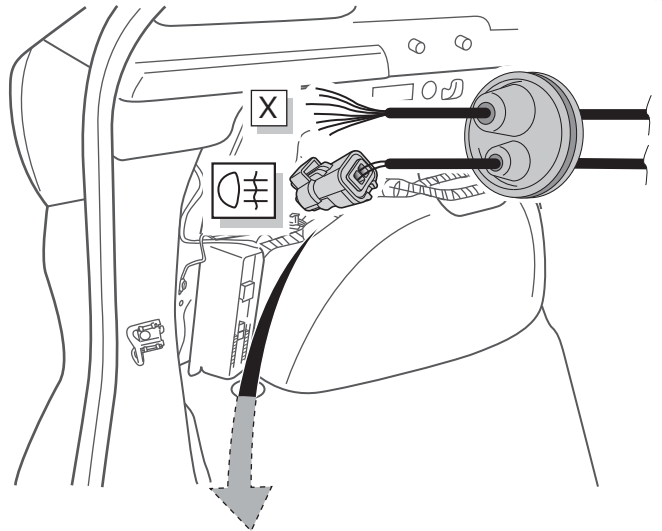

3

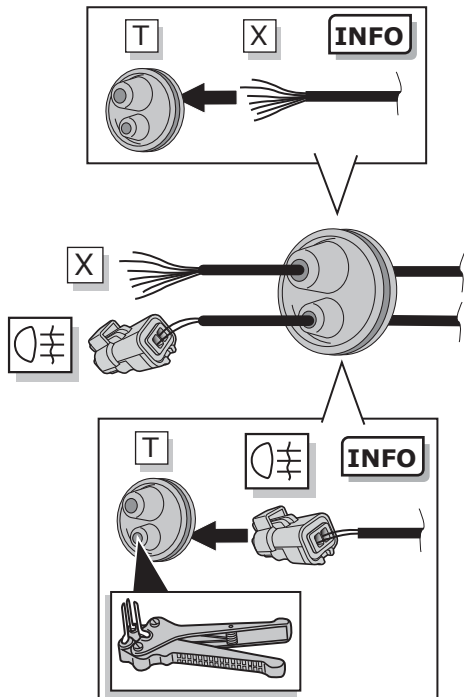

5

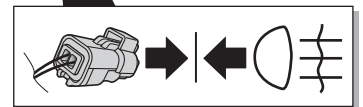
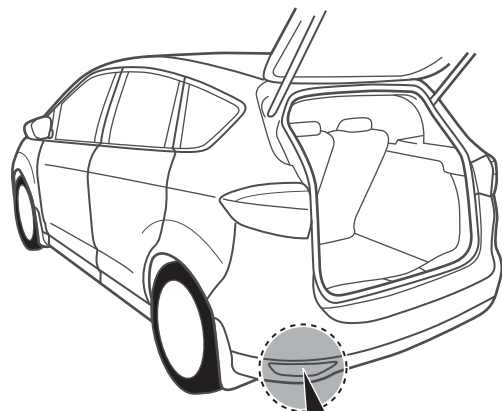

OPTION 2

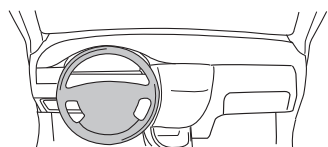

C-Max II LHD

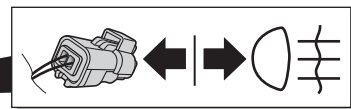
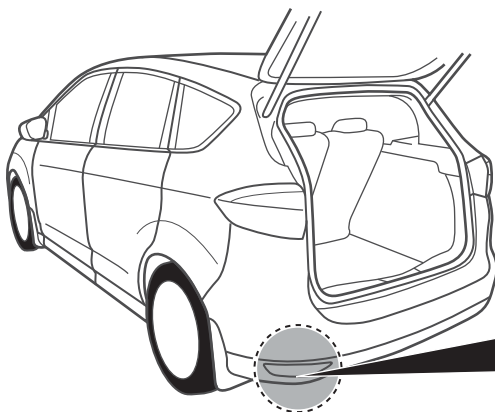

1

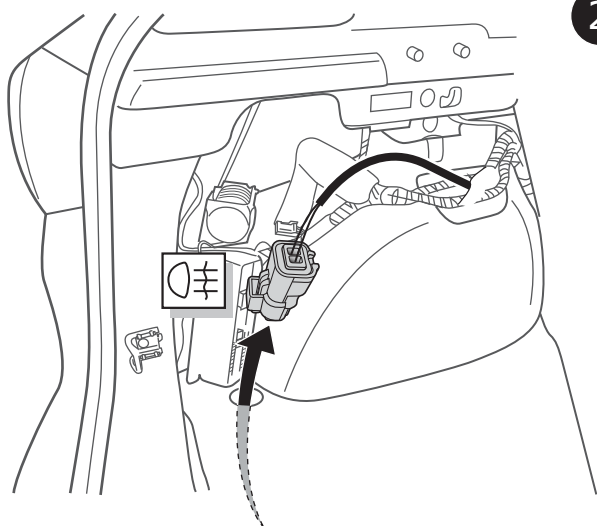

2

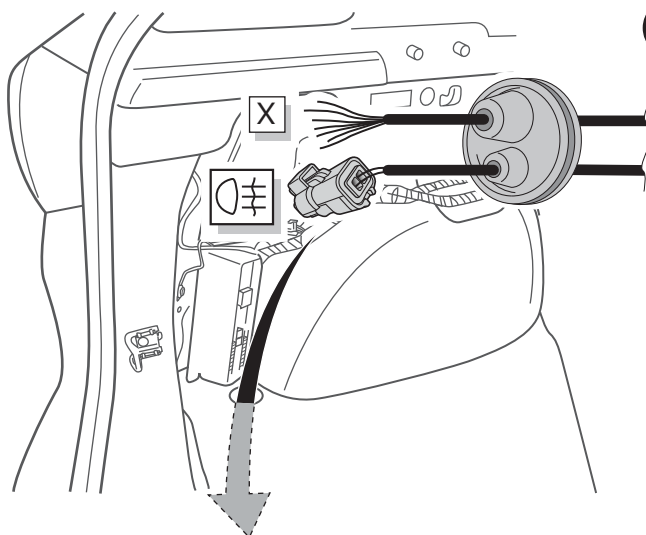

5

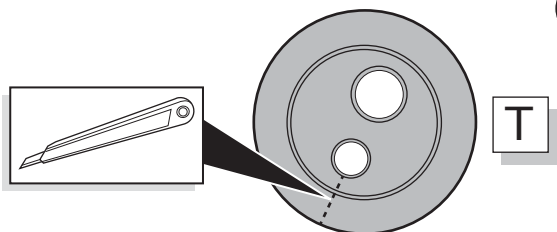

3

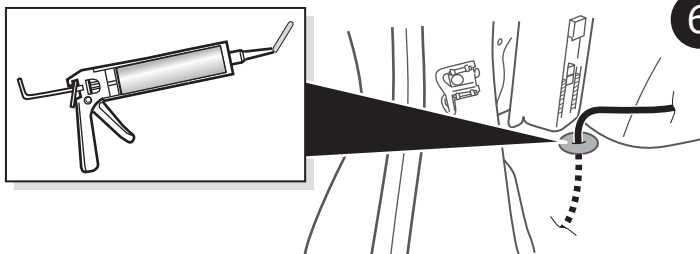

6

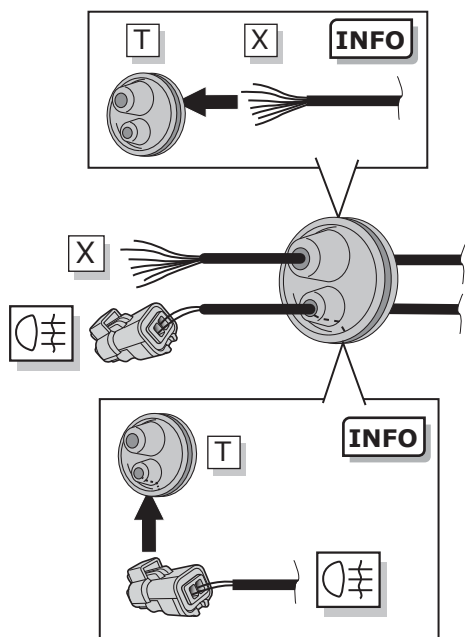

4

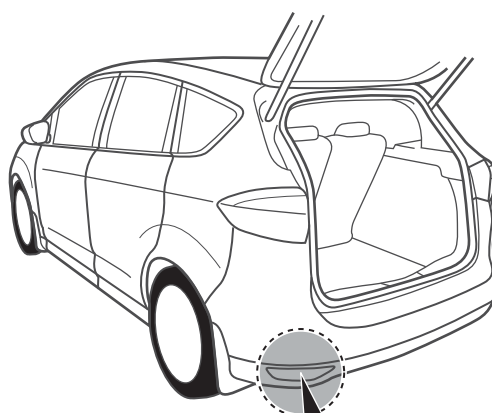

7

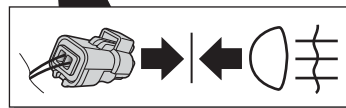

OPTION 3

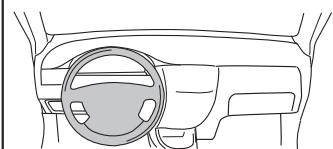

C-Max II LHD

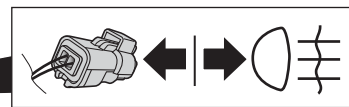
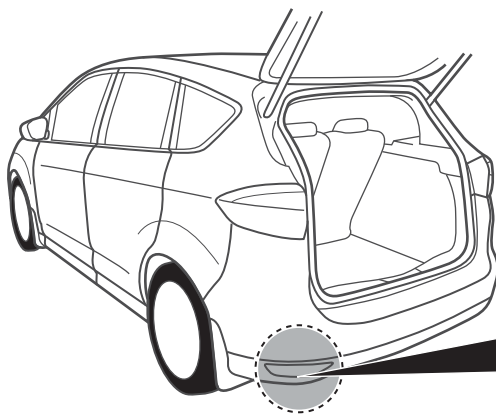

1

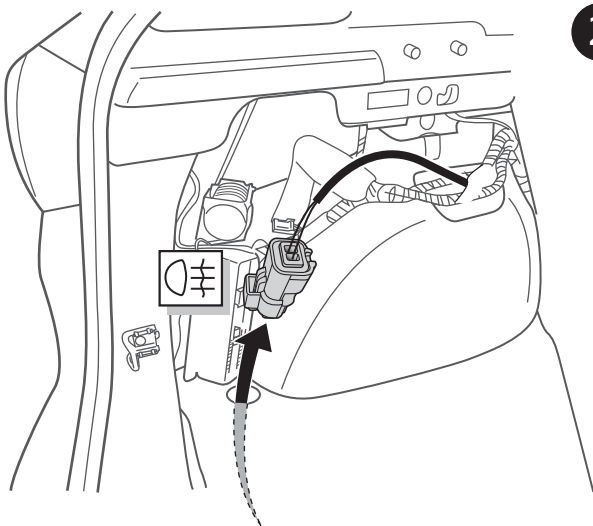

2

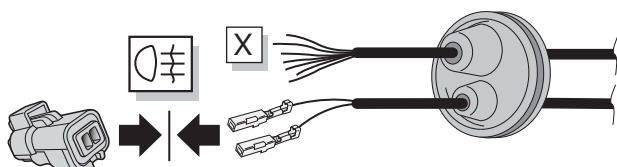

5

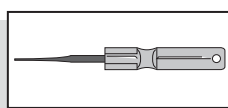
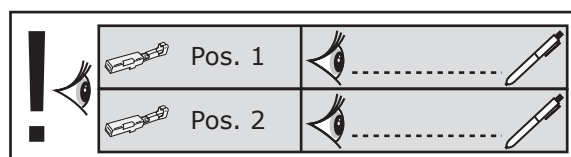

3

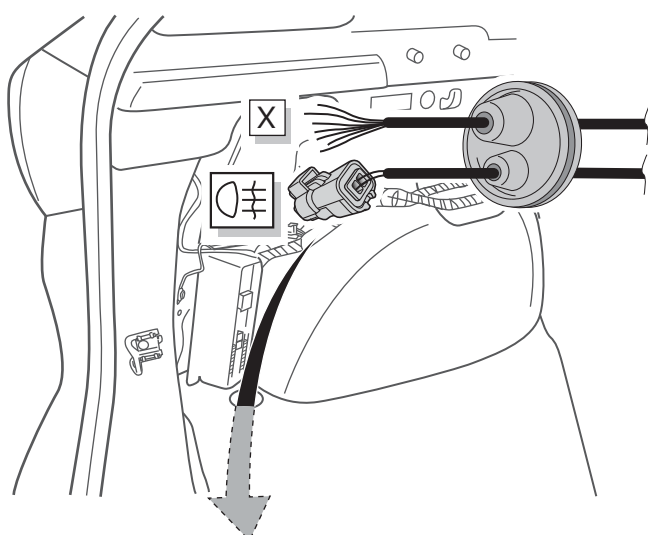
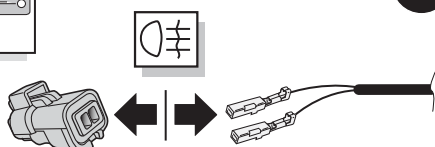

6

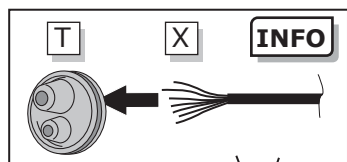

4

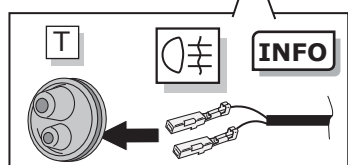
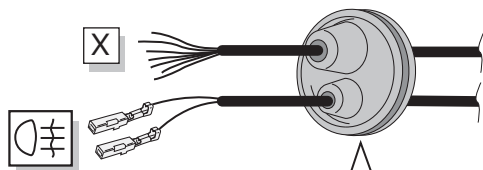

7

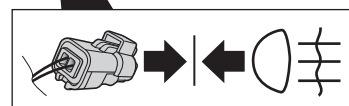
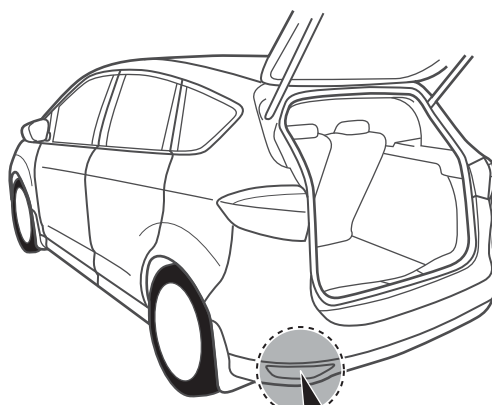

OPTION 4

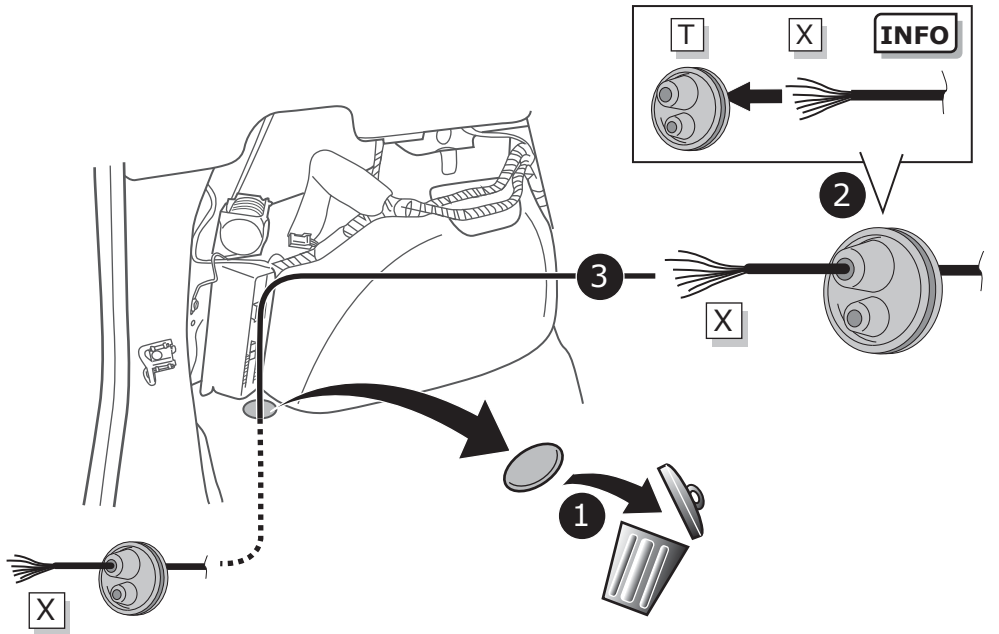
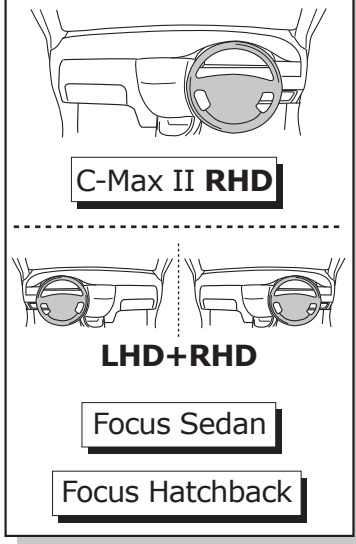

A

Option 1

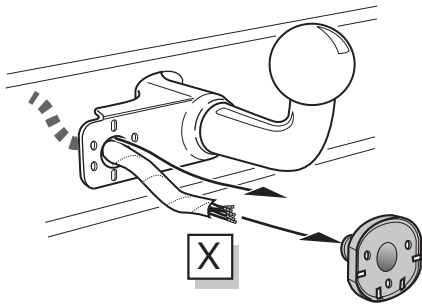

Option 2

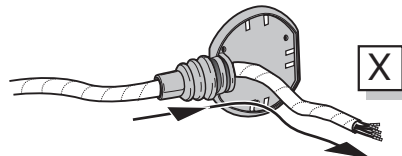

Option 3

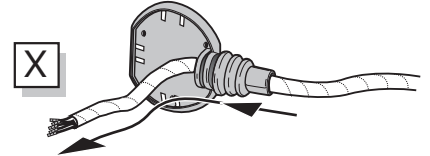

INFO

SOCKET CONNECTION 

Pag. 13

B

Option 1

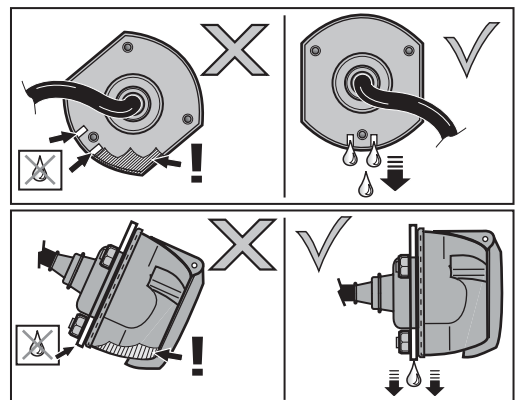
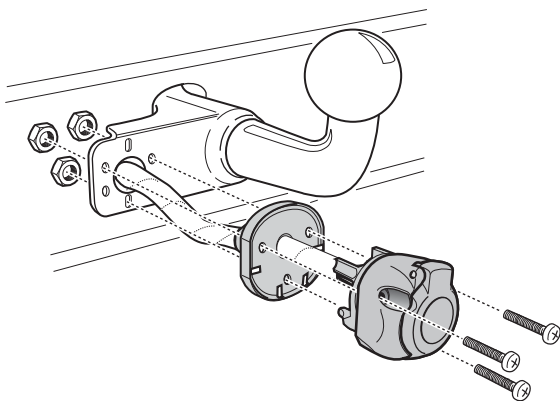

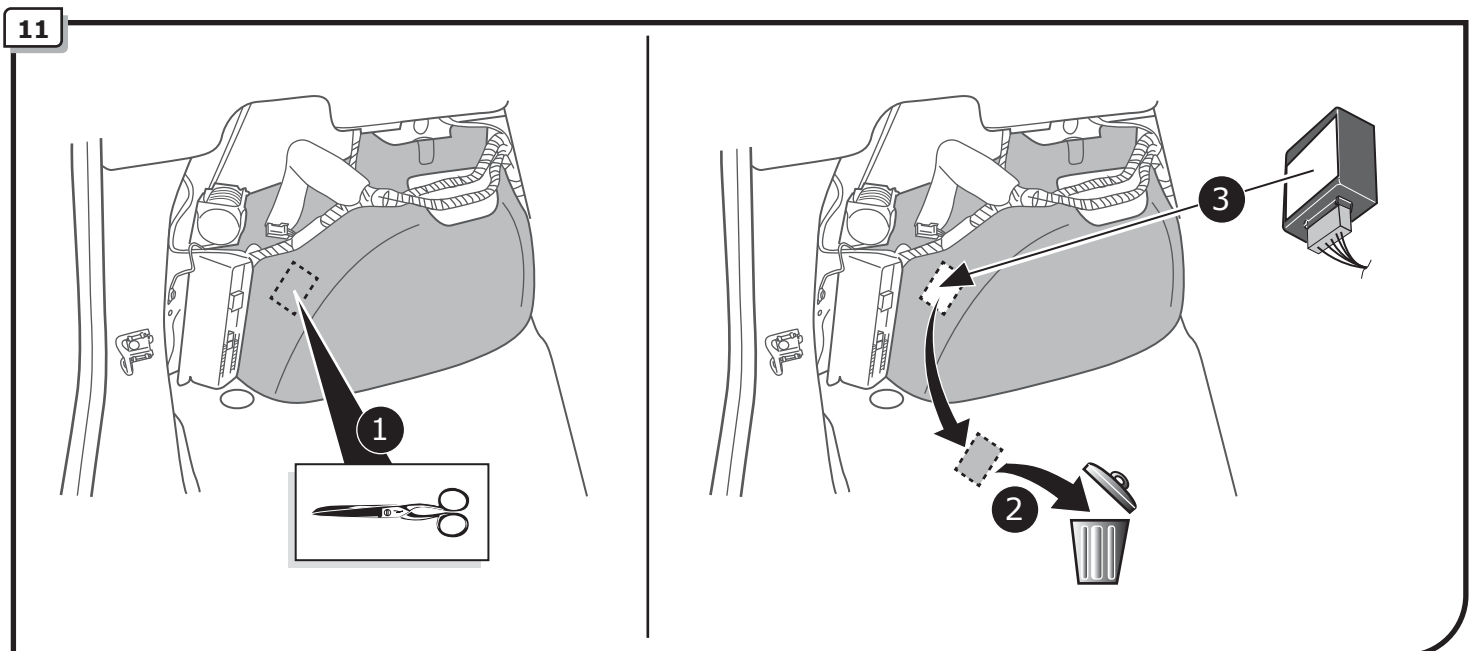
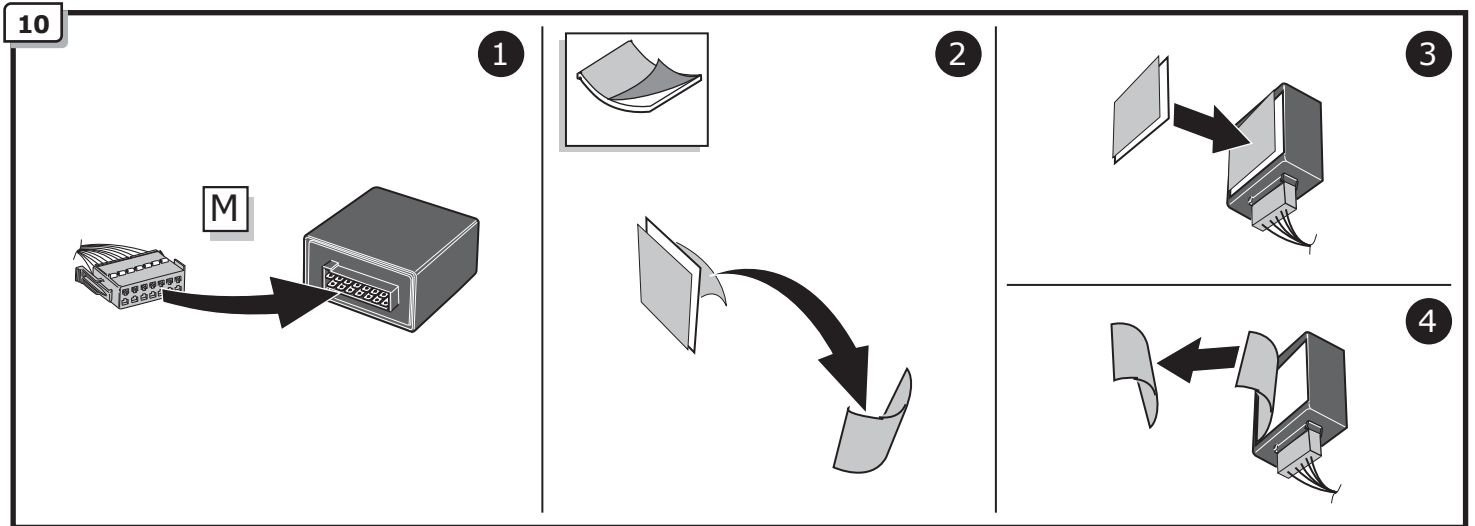
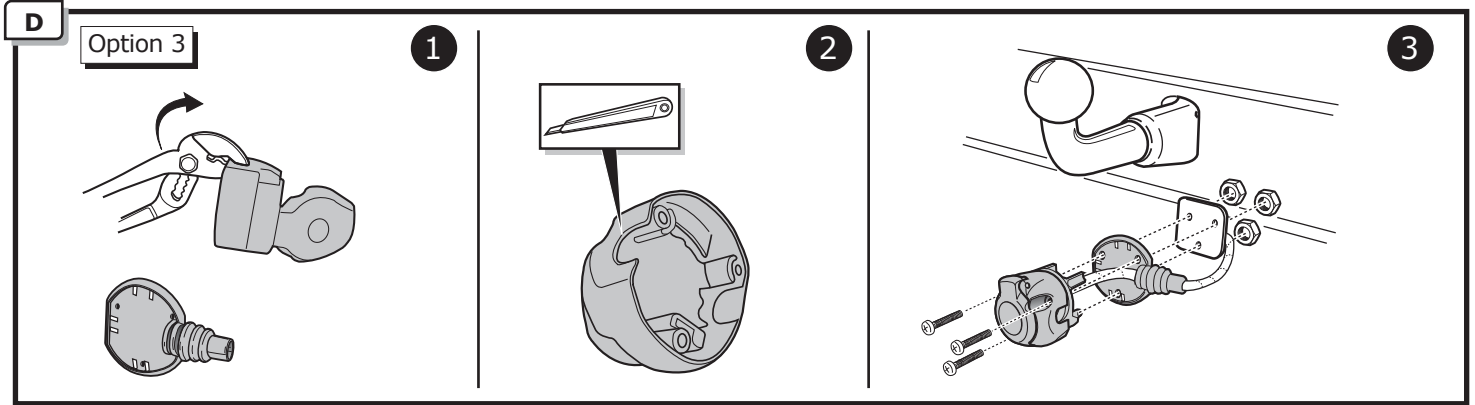
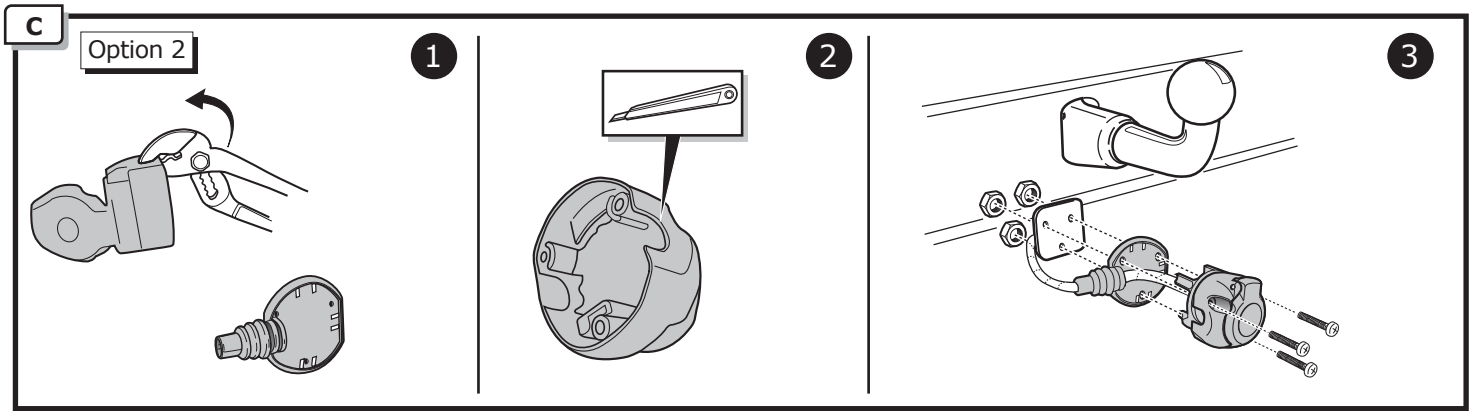

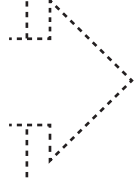
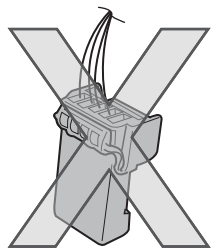
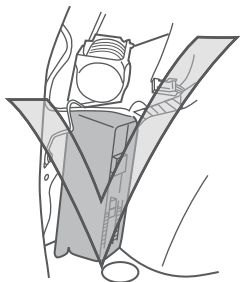
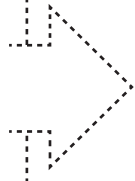
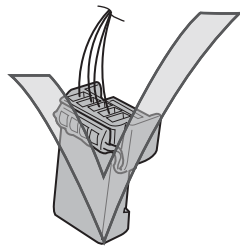
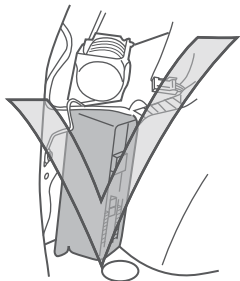
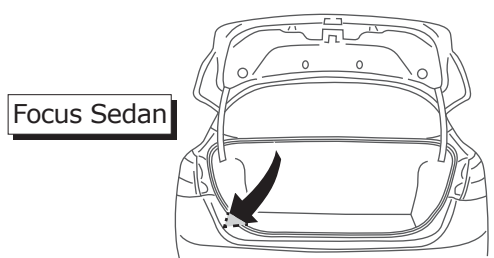
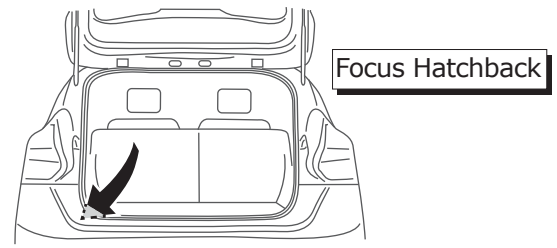
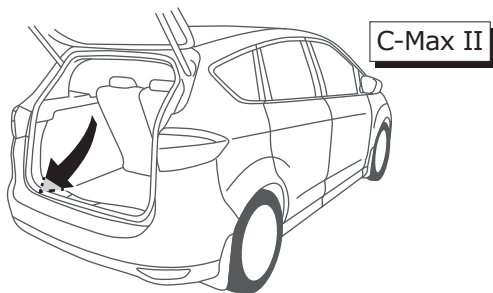

Optional
FR-050-YZ & UN-094-YZ

 **Pag. 14**

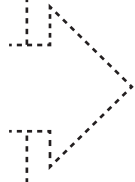
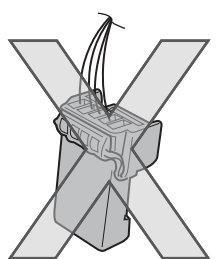

12

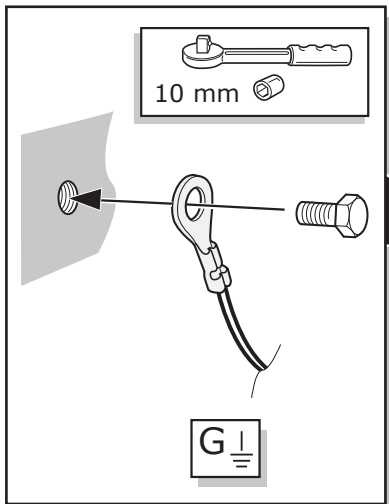

2

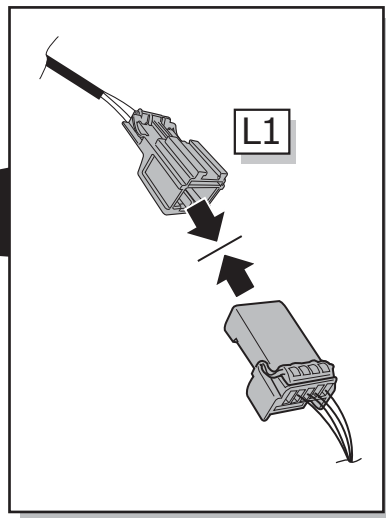
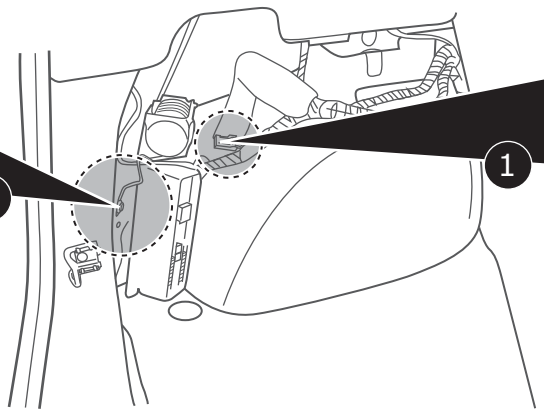

13

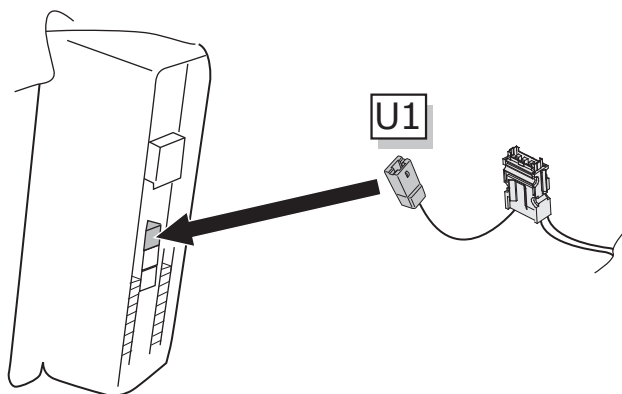
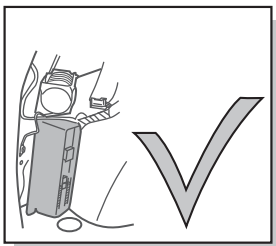

14

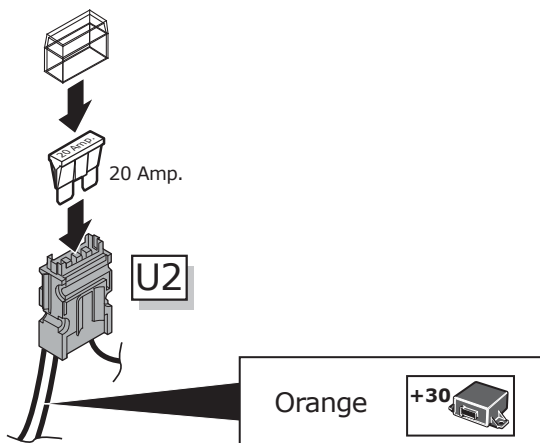

15

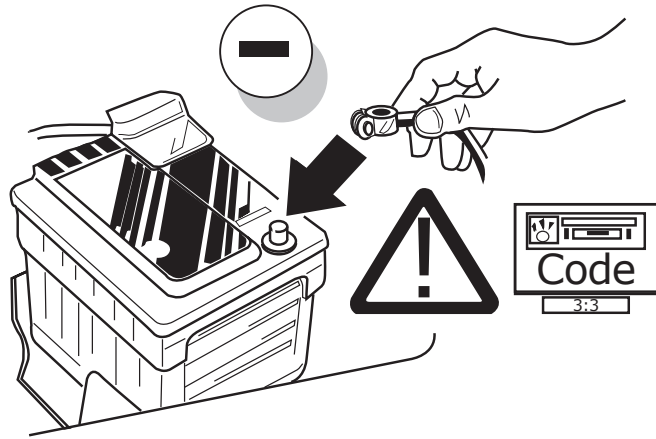

16

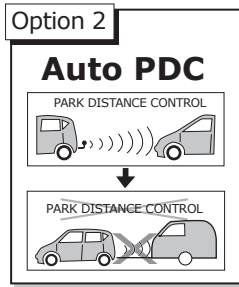
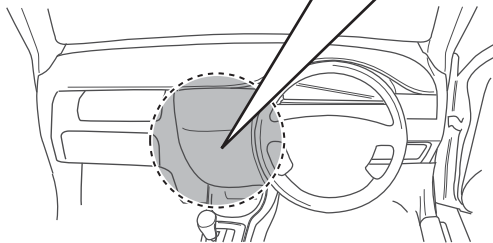
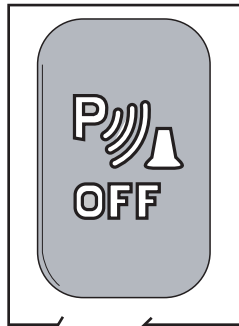
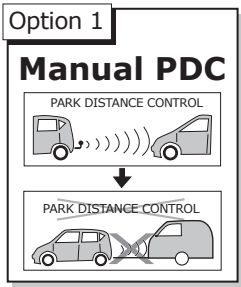

Parameter 20
Parameter 76

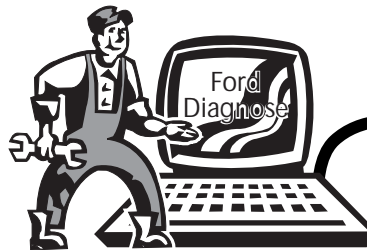

17



TEST ALL THE CIRCUITS WITH A TEST DEVICE WITH THE CORRECT POWER LOAD FOR EACH FUNCTION. A TEST DEVICE WITH LED'S CANNOT BE USED FOR THIS PURPOSE.

INFO

REINSTALL TRIM.

18

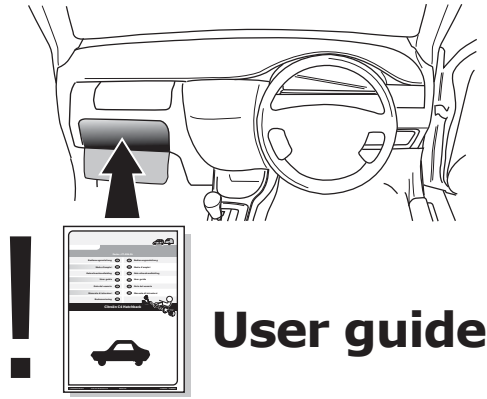

INFO

SOCKET CONNECTION

| | | | | | | | |
|-----------------|--------|------|-------|-------|--------|-------|--------|
| DIN/ISO 1724 | | | | | | | |
| | 1/L | 2 | 3/31 | 4/R | 5/58-R | 6/54 | 7/58-L |
| Pmax | 21W | 21W | | 21W | 42W | 3x21W | 42W |
| Colour | Yellow | Blue | White | Green | Brown | Red | Black |

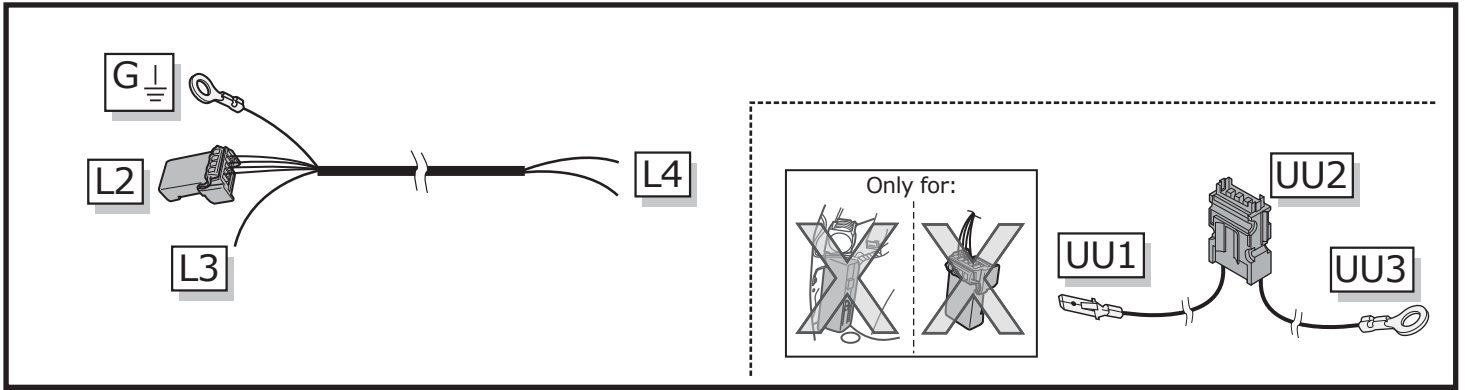

ROUTING

C-Max II: option 1

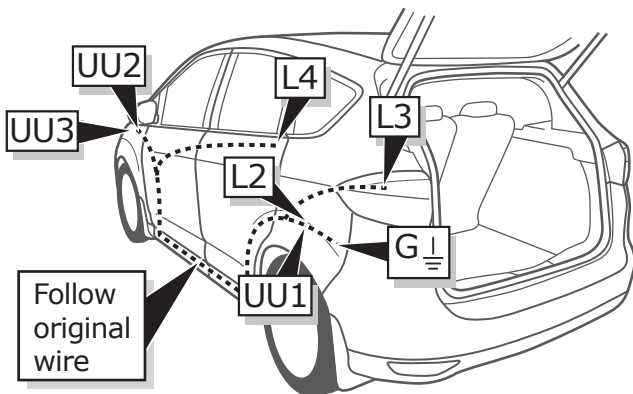

C-Max II: option 2

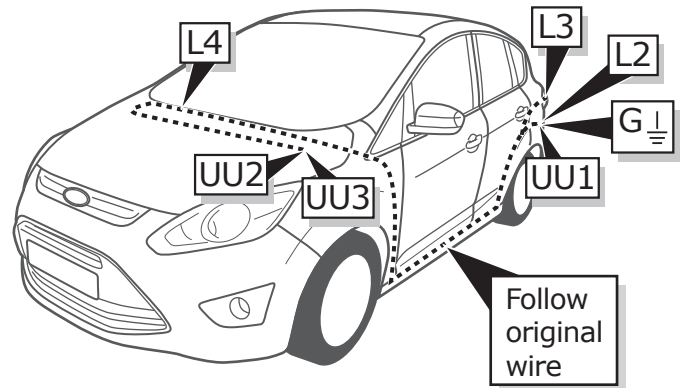

Focus Sedan: option 1

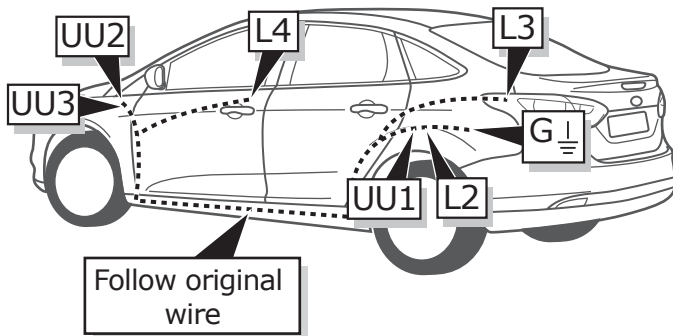

Focus Sedan: option 2

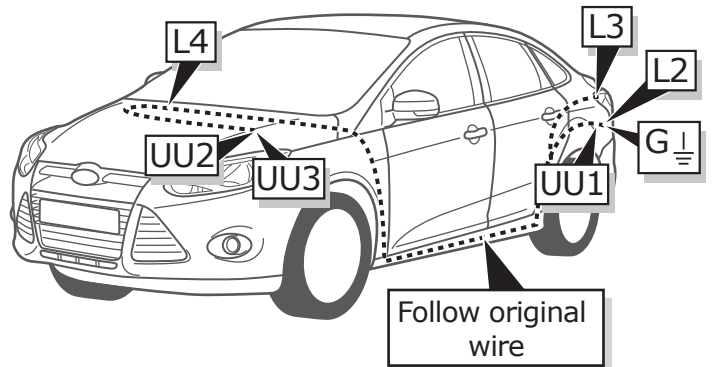

Focus Hatchback: option 1

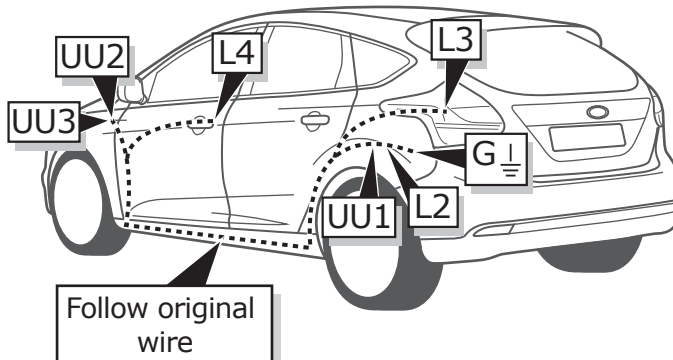

Focus Hatchback: option 2

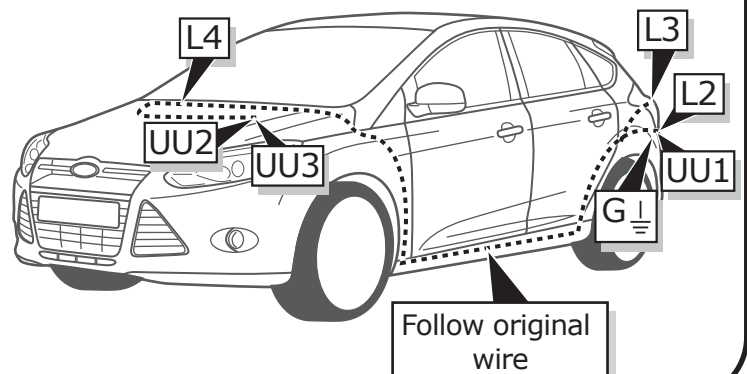

A

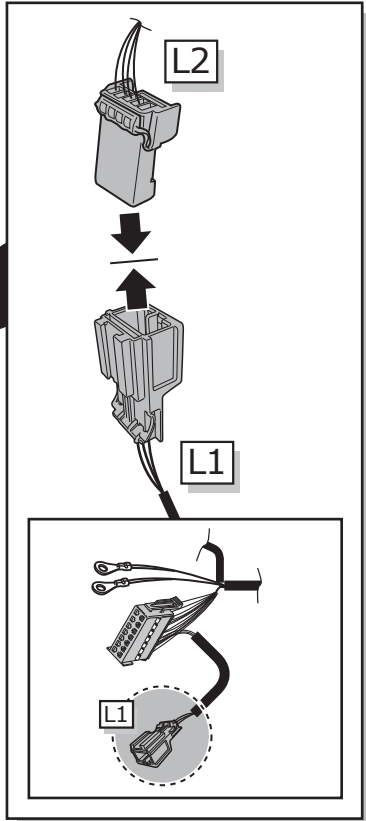
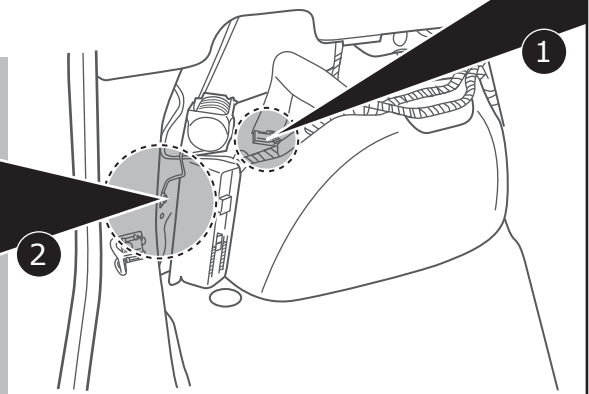
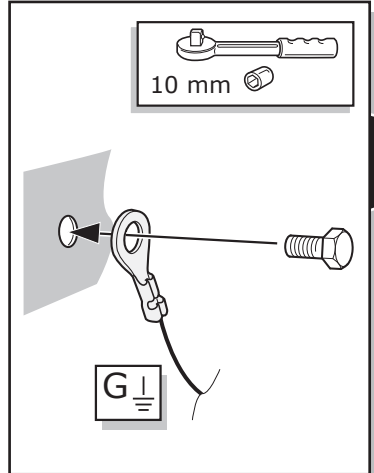
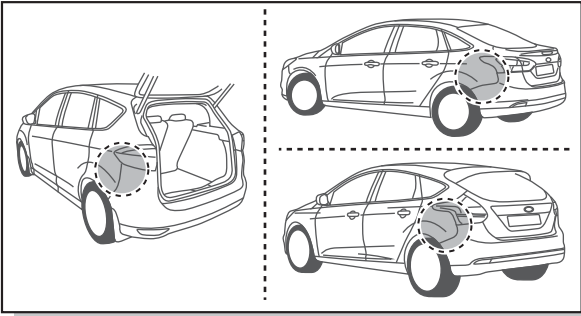

B

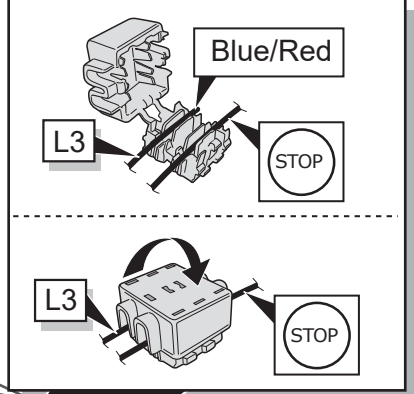
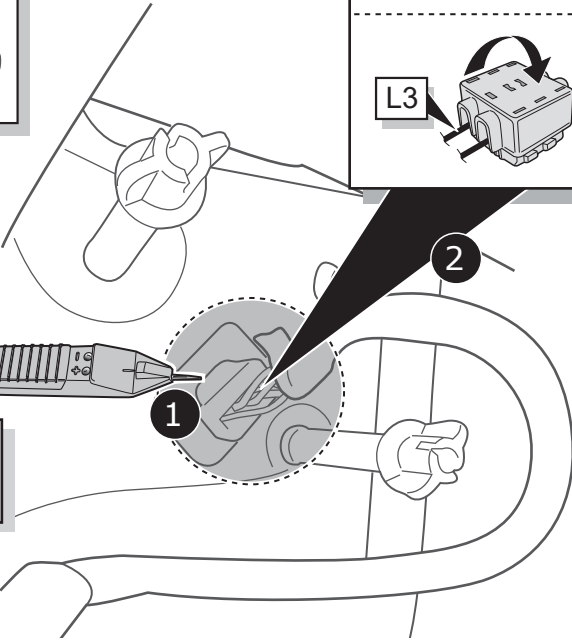
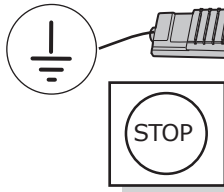
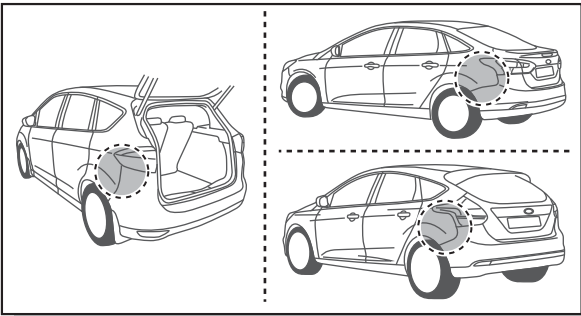



C

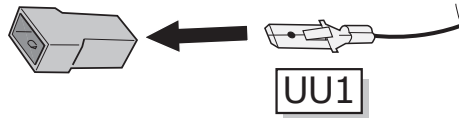
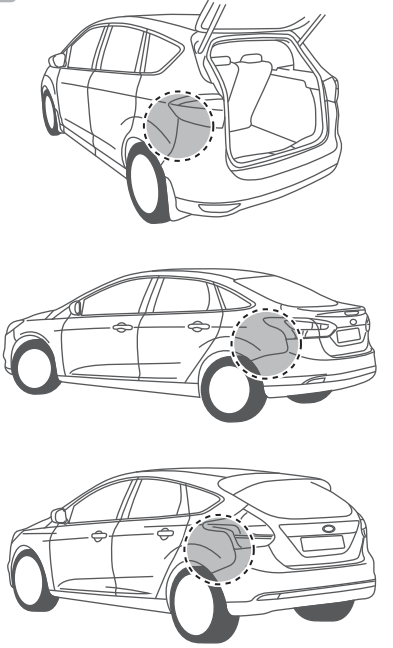

1

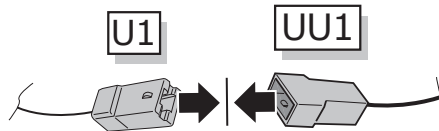

2

D

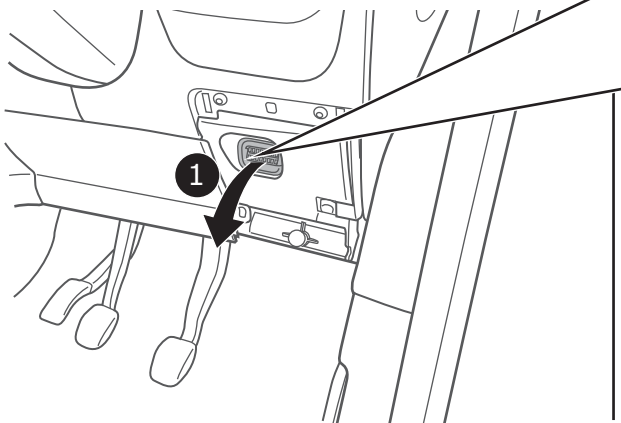
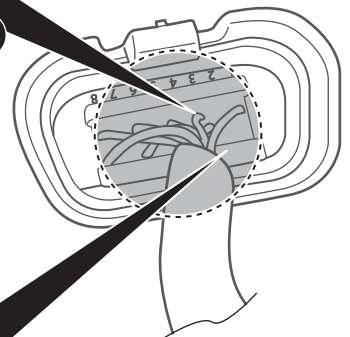
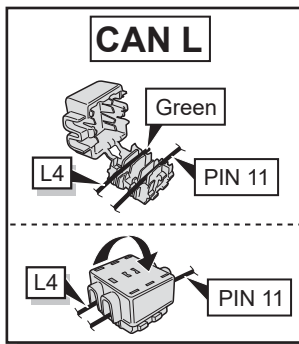
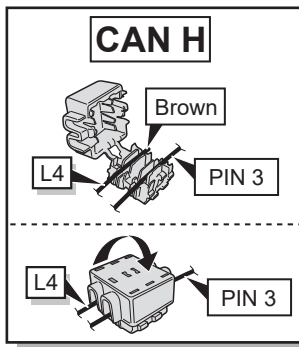
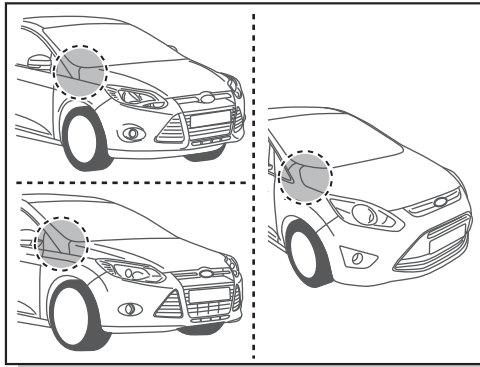



E

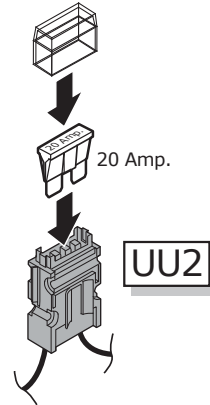
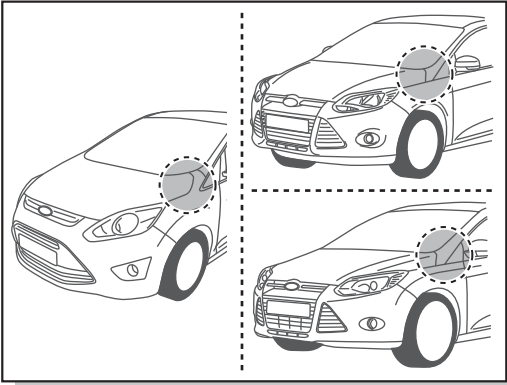

F

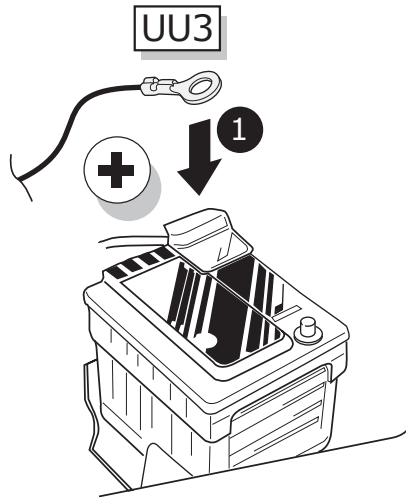

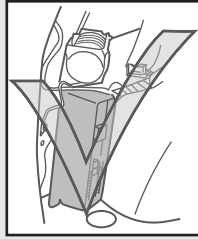

G

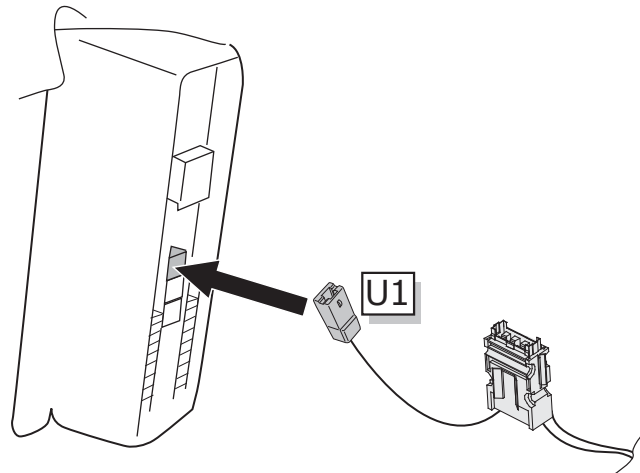

H

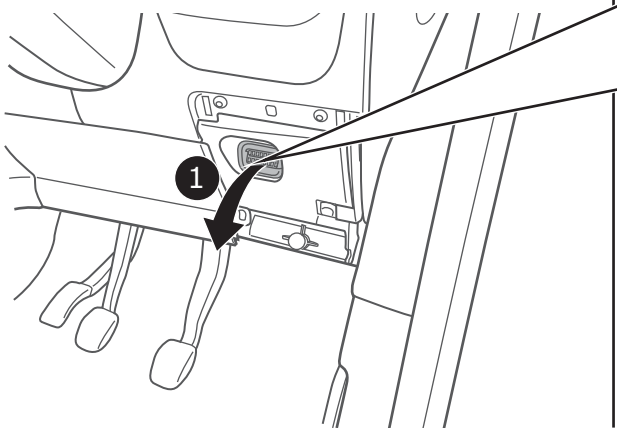
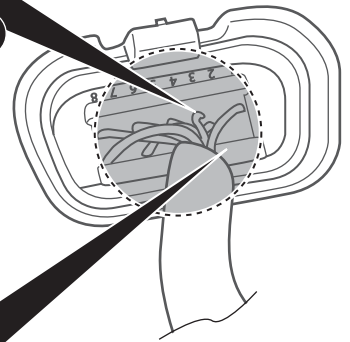
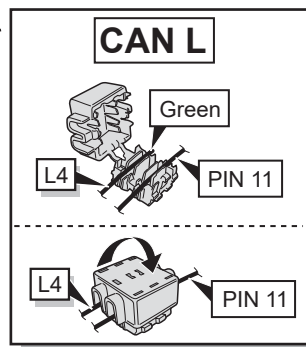
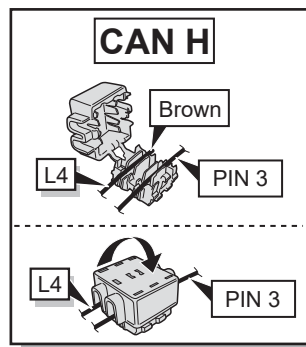
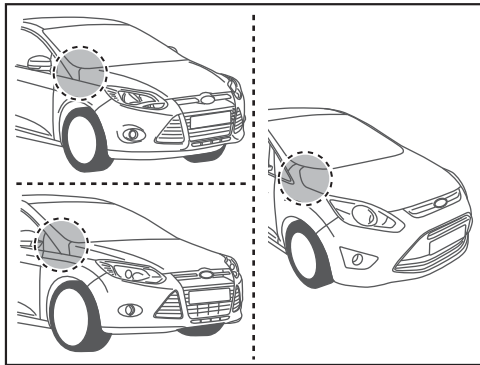

4

Pag. 12

15

UN-243-YZ Reverse lamp pre-wire extension

⚠ MAX = 21W

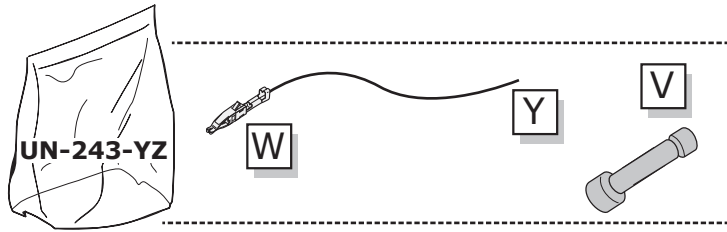

A

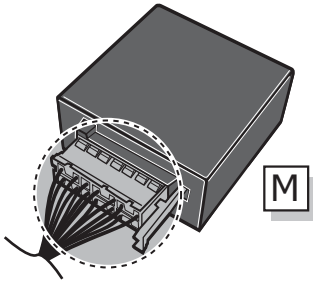

1

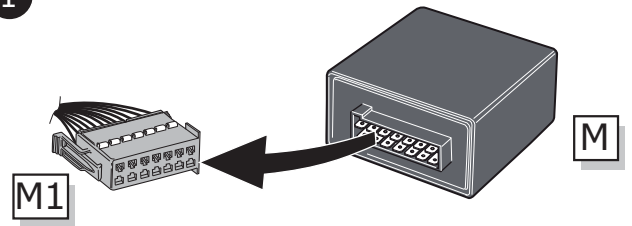

2

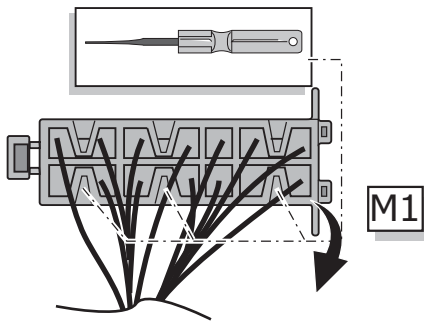

3

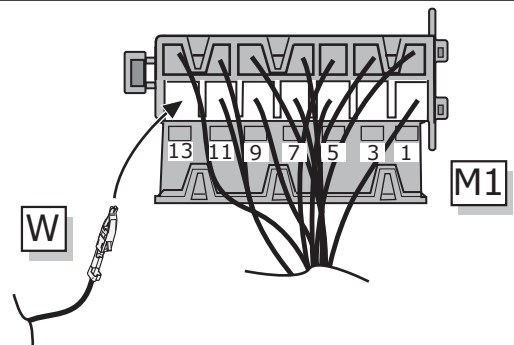

4

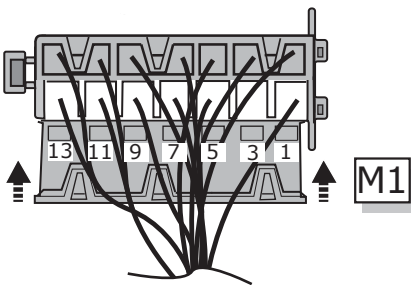

5

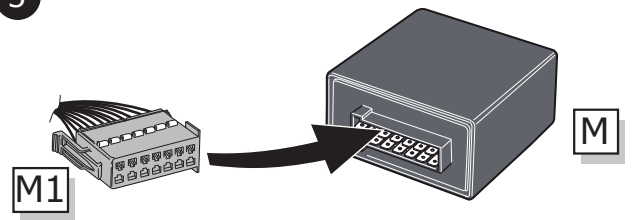

B

⚠ MAX = 21W

