

Ford C-MAX II **07/2010 >>**

Ford Focus Sedan **01/2011 >>**

Ford Focus Hatchback **01/2011 >>**

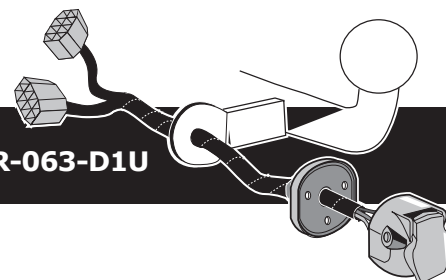

Partnr.: **FR-063-D1U**

- Fitting instructions electric wiring kit tow bar with 13-P socket up to DIN/ISO Norm 11446.
- We would expressly point out that assembly not carried out properly by a competent installer will result in cancellation of any right to damage compensation, in particular those arising by virtue of the product liability act.
- Contents of these kits and their fitting manuals are subject to alteration without notice, please ensure that these instructions are read and fully understood before commencing installation.
- Do not overload circuits; the maximum loads per connection are detailed in this manual.
- Attention! Before Installation, please read this manual carefully and inform your customer to consult the vehicle owners manual to check for any vehicle modifications required before towing.
- In the event of functional problems, troubleshooting must be limited to about 0.5 hours, contact the technical support:
ukts@ecs-electronics.com / 07440 202 052.



Part list

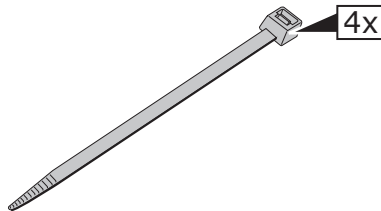
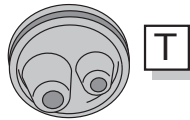
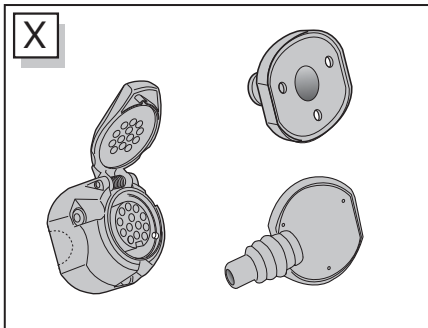
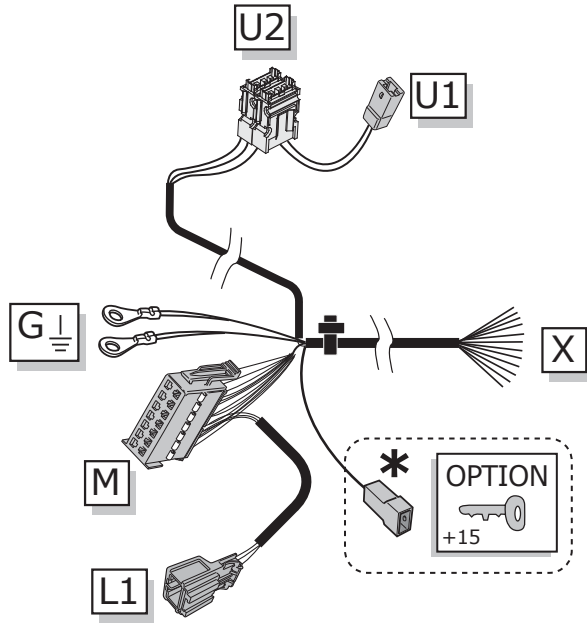
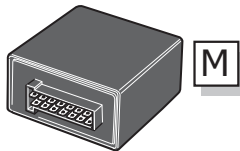
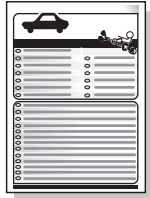
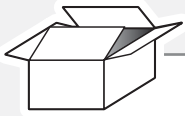

Optional
FR-050-YZ & UN-094-YZ

Pag. 11

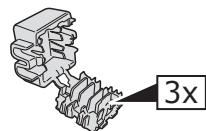
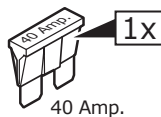
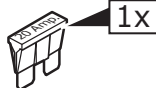
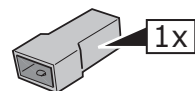
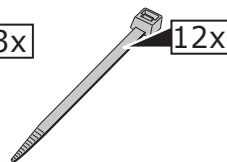
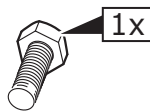
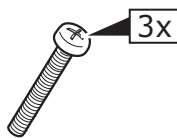

ROUTING

C-Max II

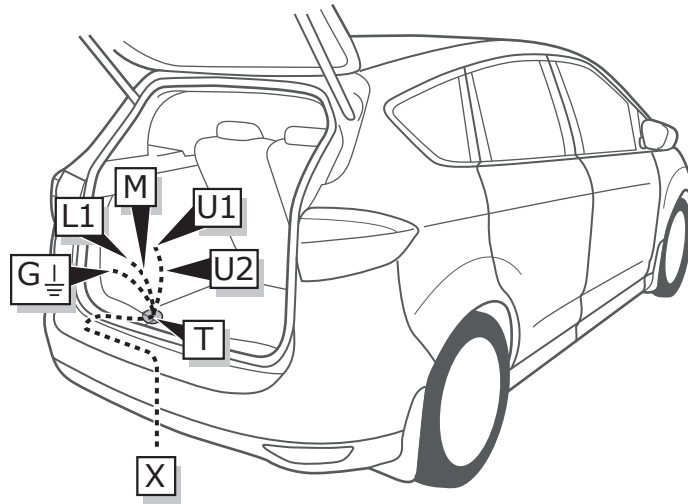

Focus Sedan

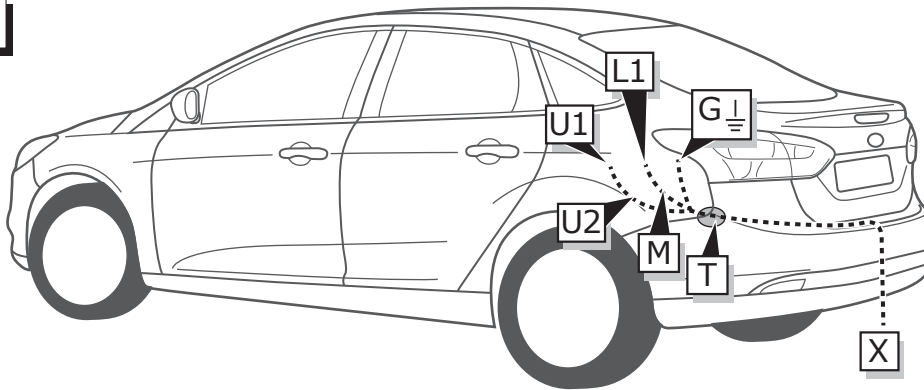

Focus Hatchback

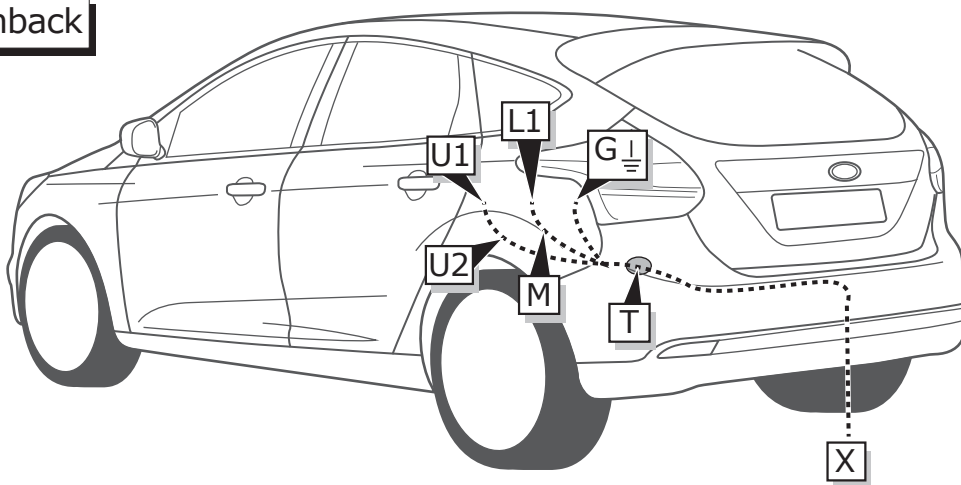

1

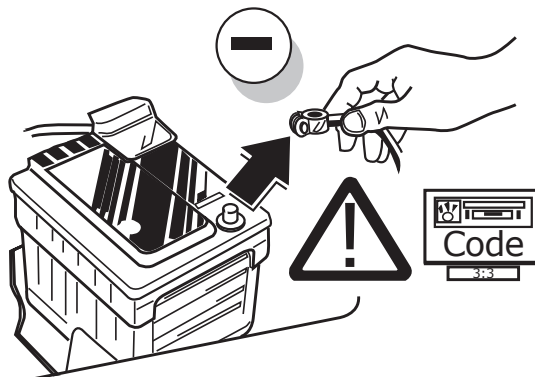

2

C-Max II

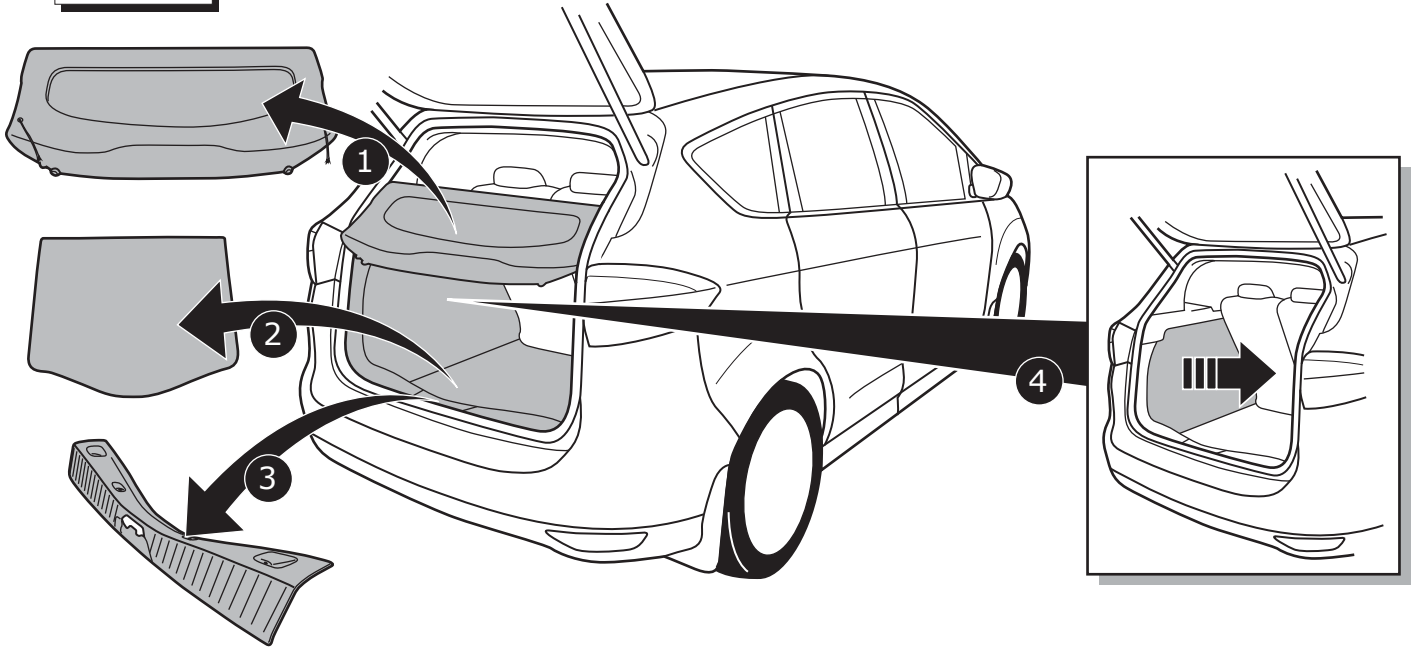

3

Focus Sedan

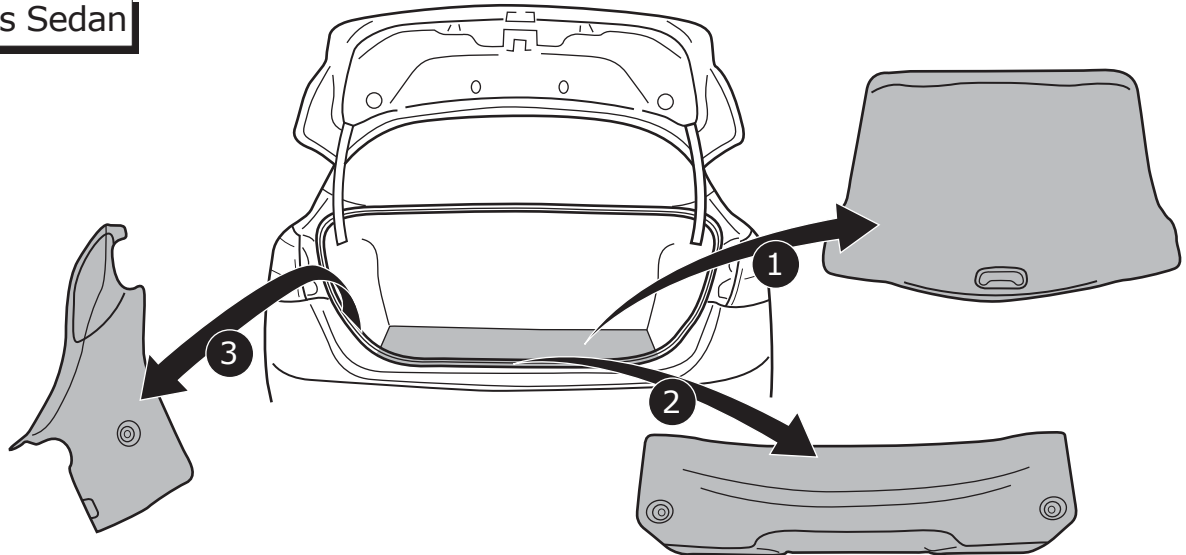

4

Focus Sedan

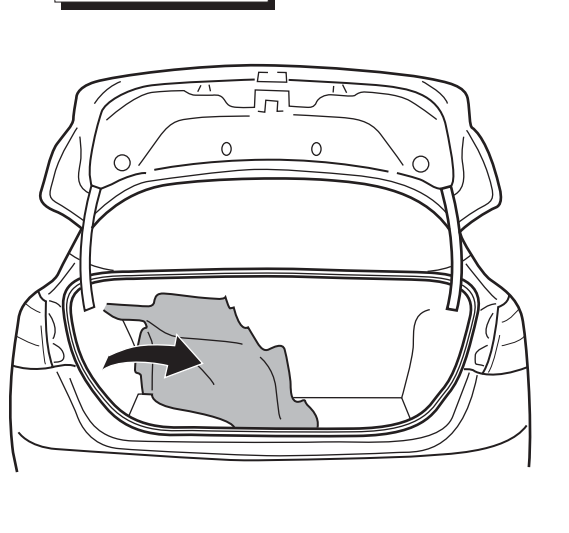

5

Focus Hatchback

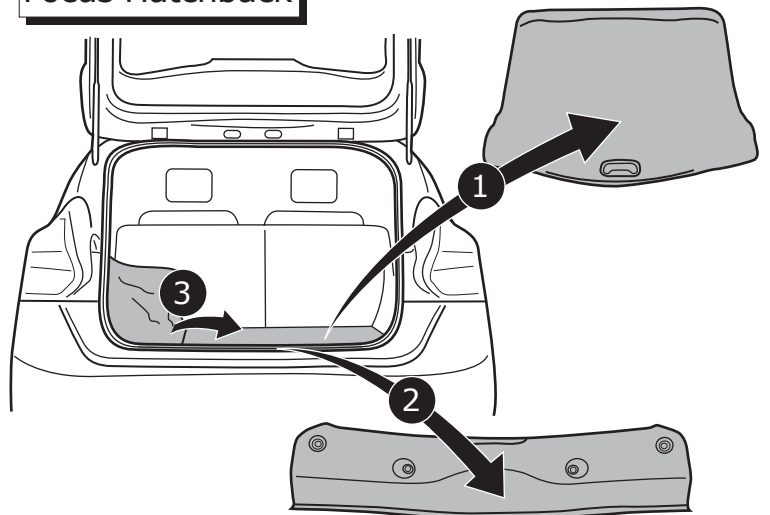

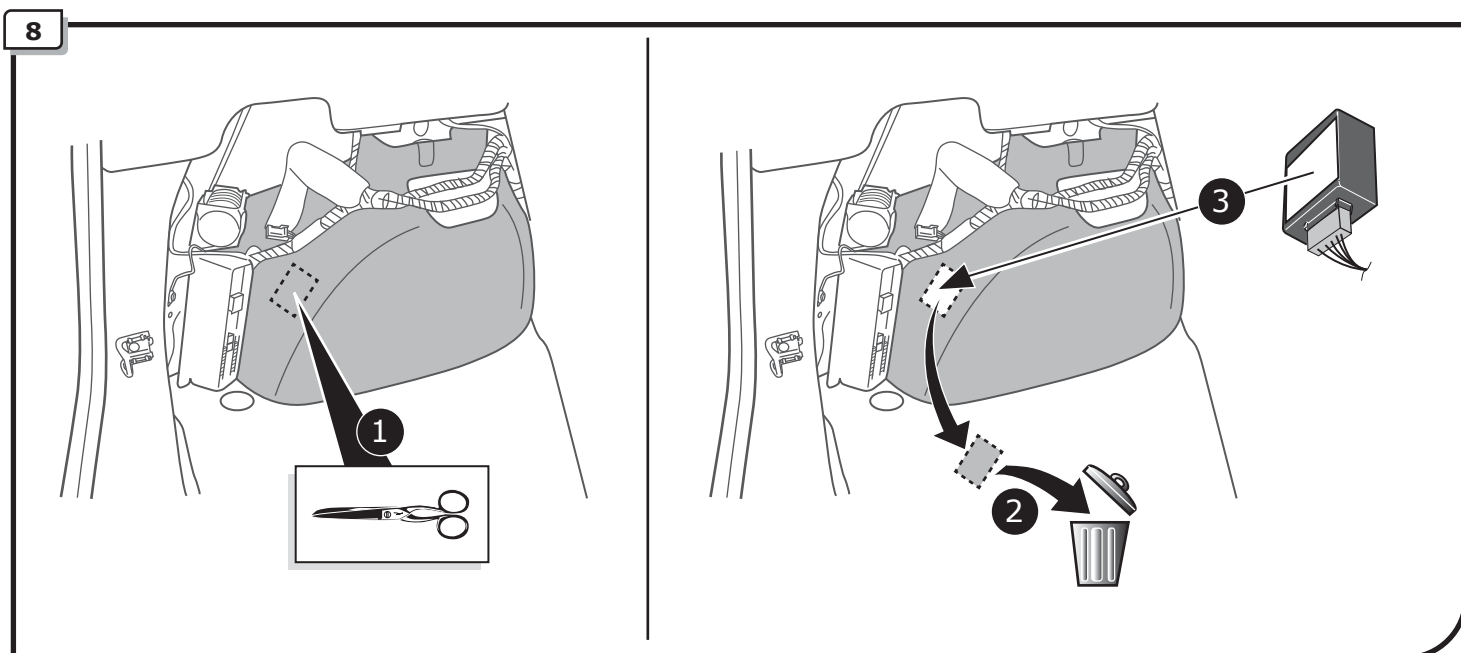
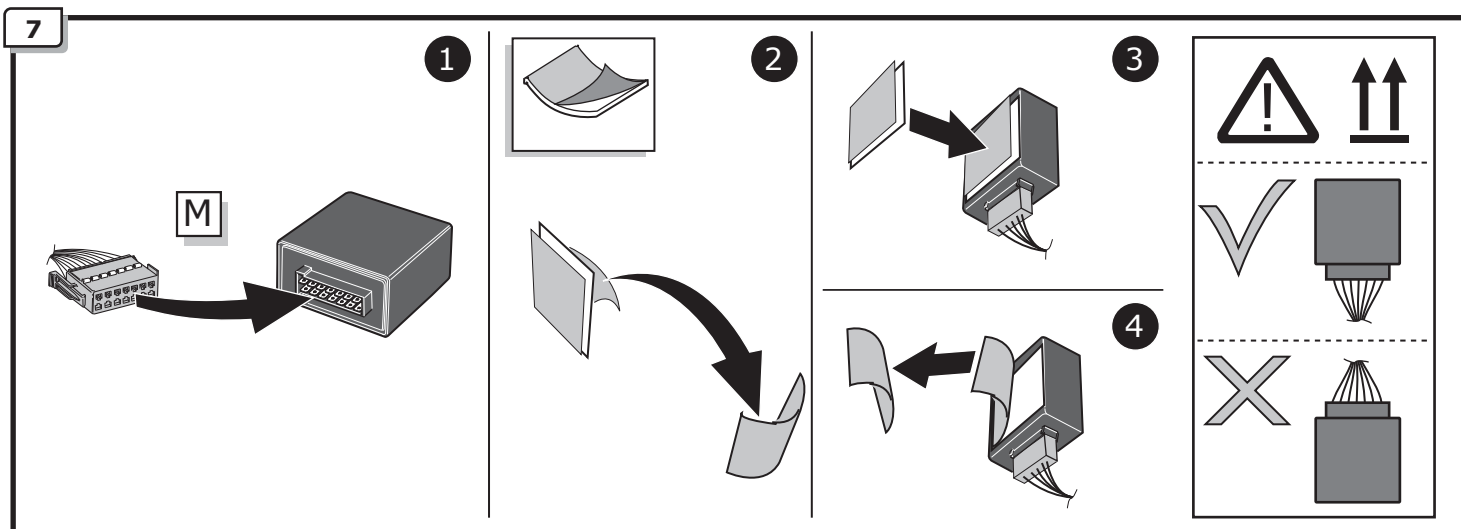
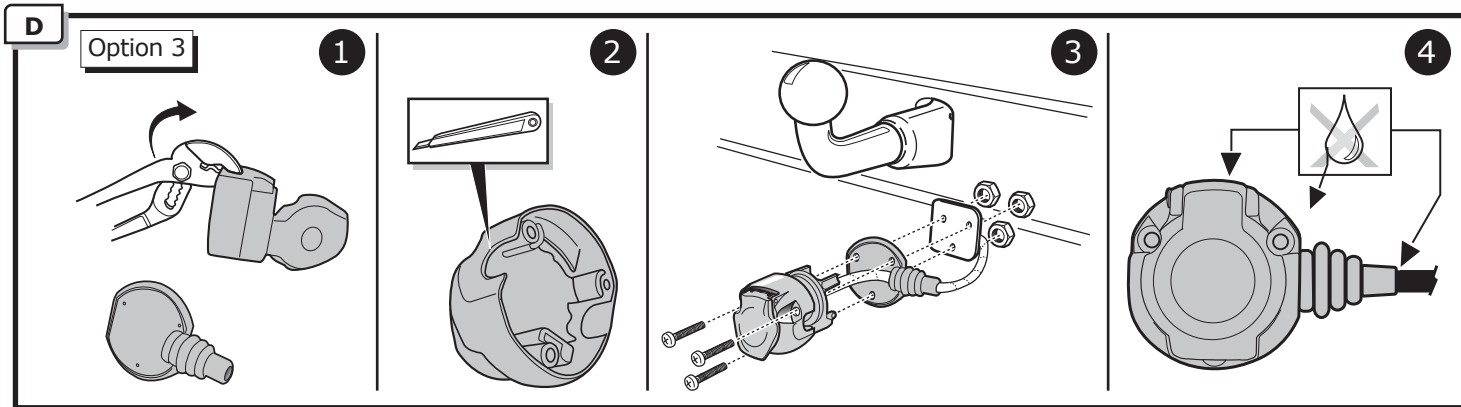
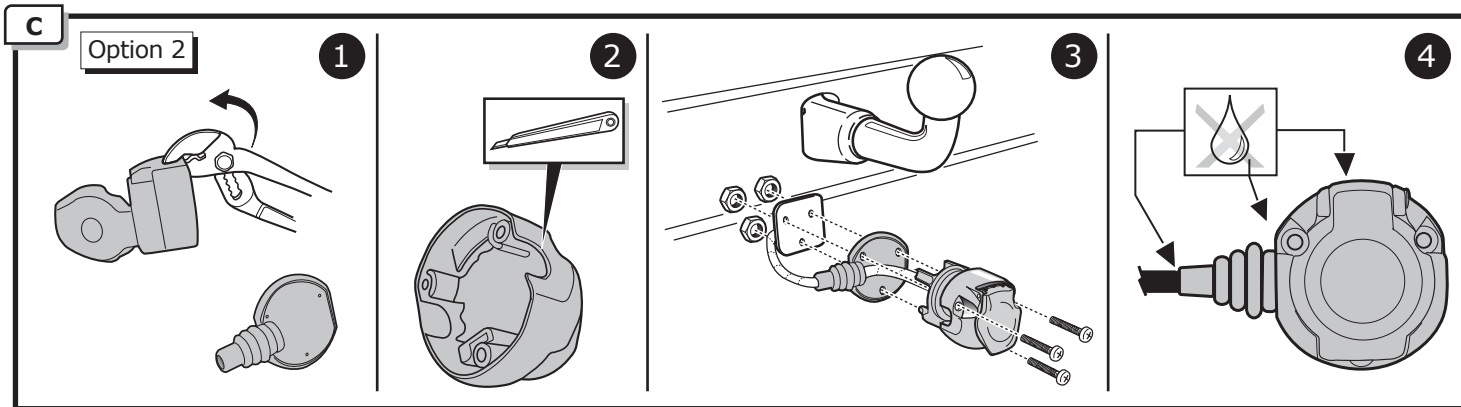

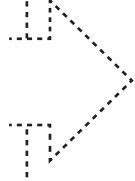
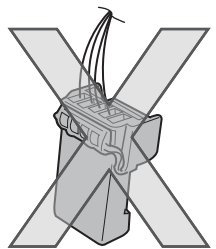
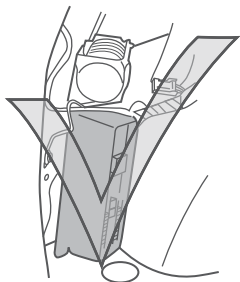
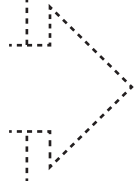
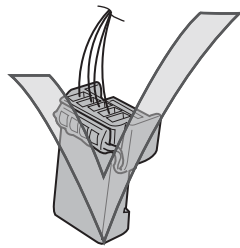
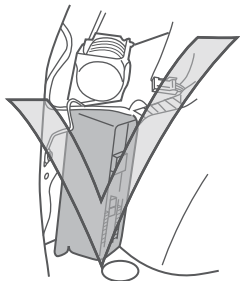
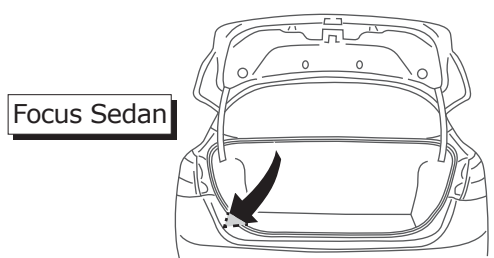
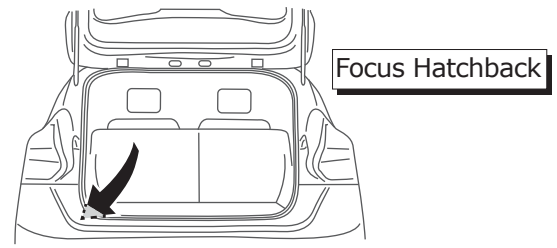
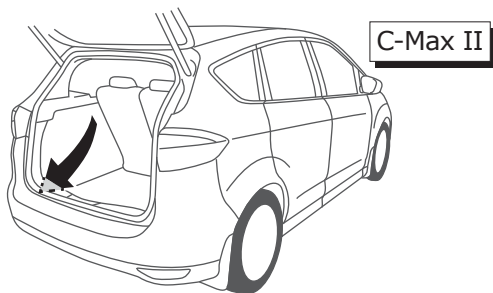

Optional
FR-050-YZ & UN-094-YZ

 **Pag. 11**

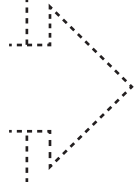
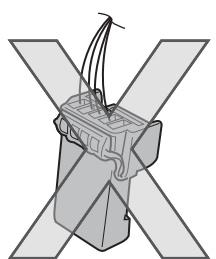

9

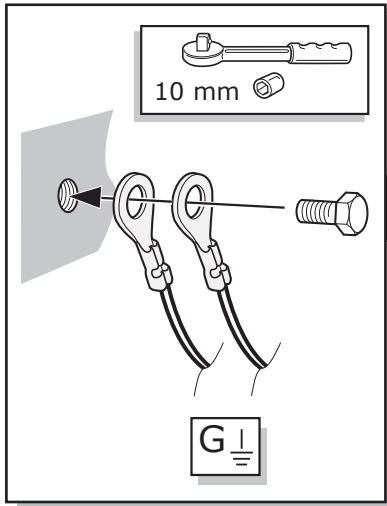

2

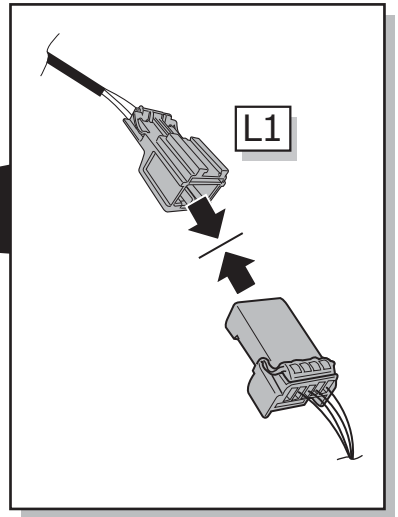
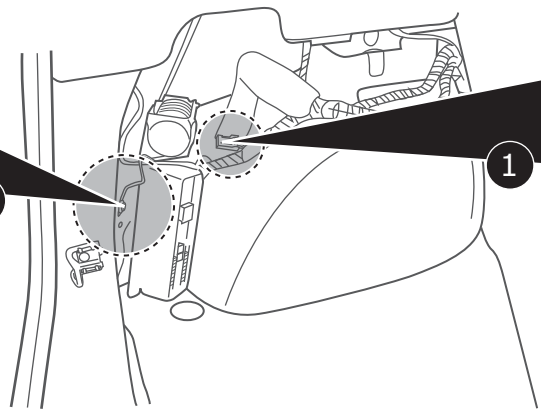

10

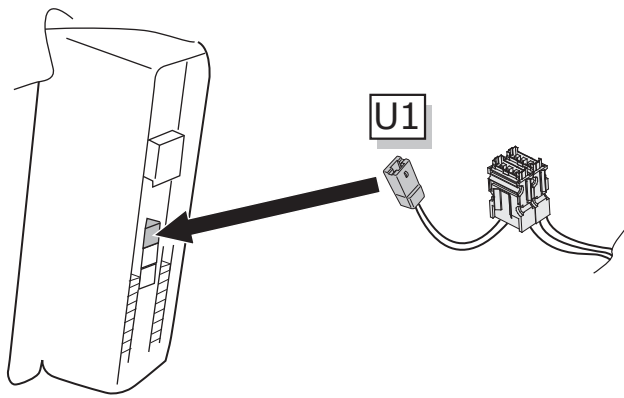
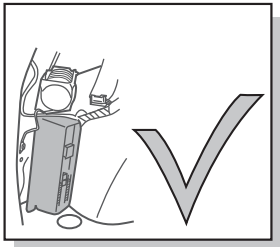

11

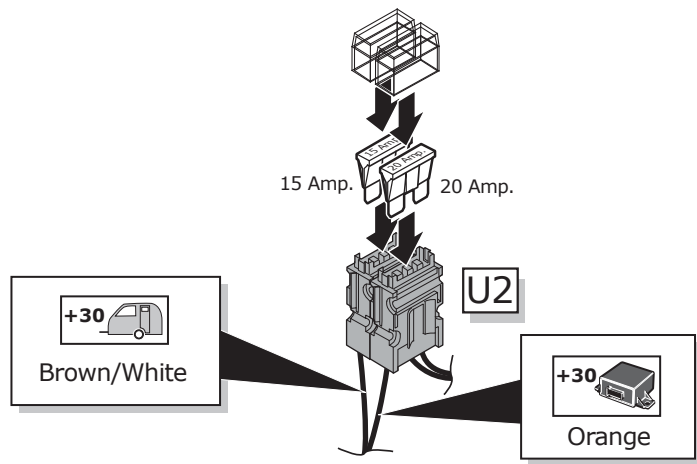

12

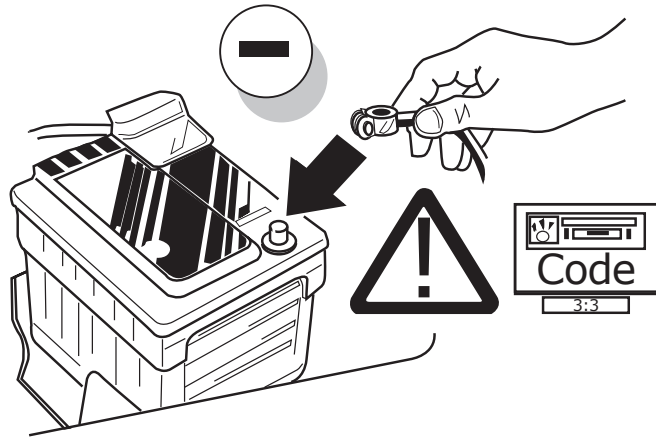

13

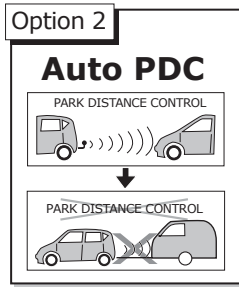
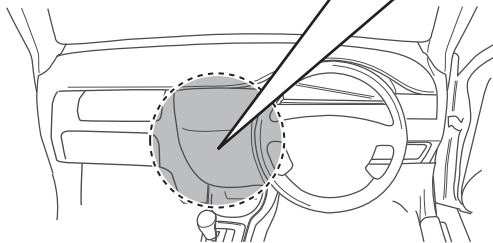
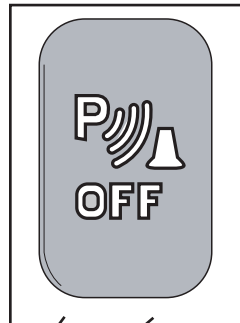
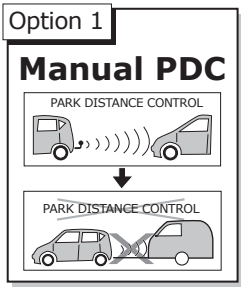

Parameter 20
Parameter 76

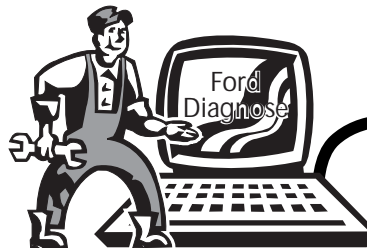

14



TEST ALL THE CIRCUITS WITH A TEST DEVICE WITH THE CORRECT POWER LOAD FOR EACH FUNCTION. A TEST DEVICE WITH LED'S CANNOT BE USED FOR THIS PURPOSE.

INFO

REINSTALL TRIM.

15

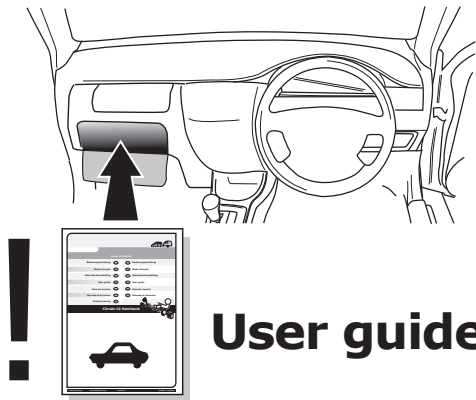

INFO

SOCKET CONNECTION

DIN/ISO 11446													
	1/L	2	3/31	4/R	5/58-R	6/54	7/58-L	8	9	10	11	12	13
Pmax	21W	21W		21W	42W	3x21W	42W	21W	180W/15Amp	180W/15Amp			
Colour	Yellow	Blue	White	Green	Brown	Red 1,00 mm ²	Black	Black/ Red	Brown/ White	Red 2,50 mm ²	White	-	White

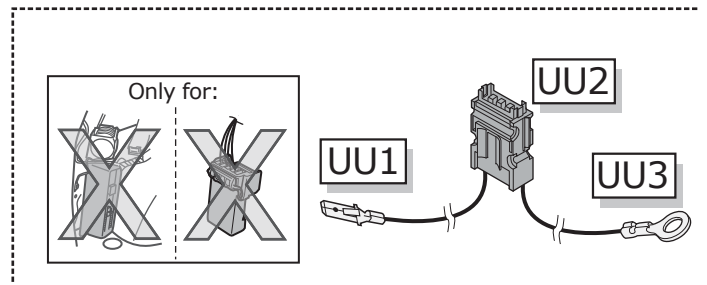
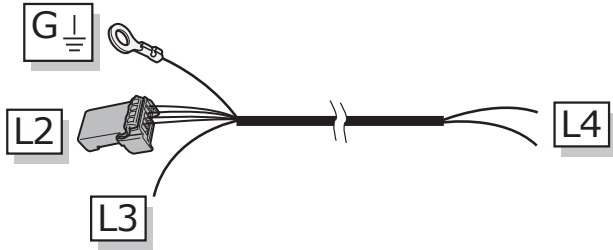

ROUTING

C-Max II: option 1

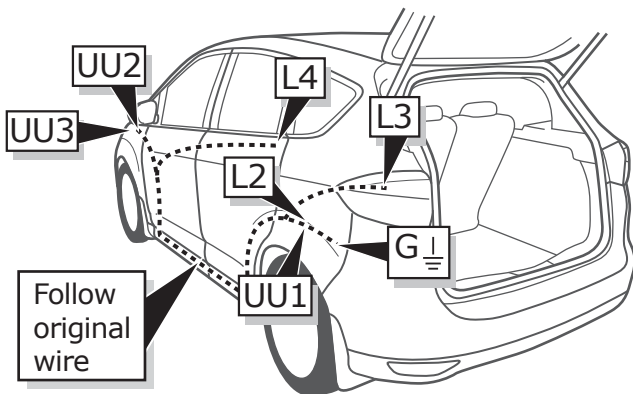

C-Max II: option 2

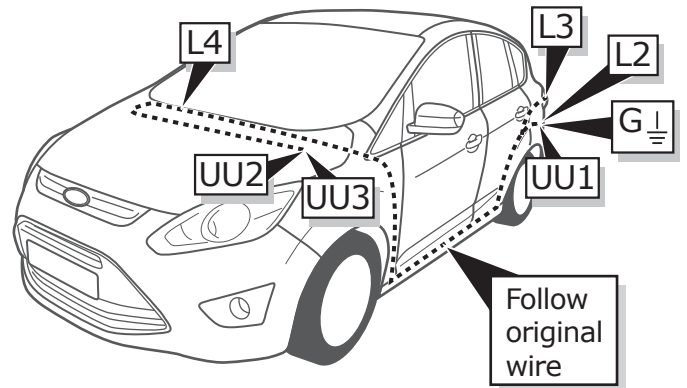

Focus Sedan: option 1

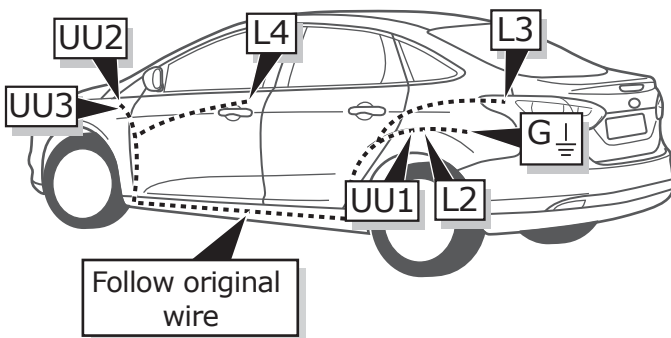

Focus Sedan: option 2

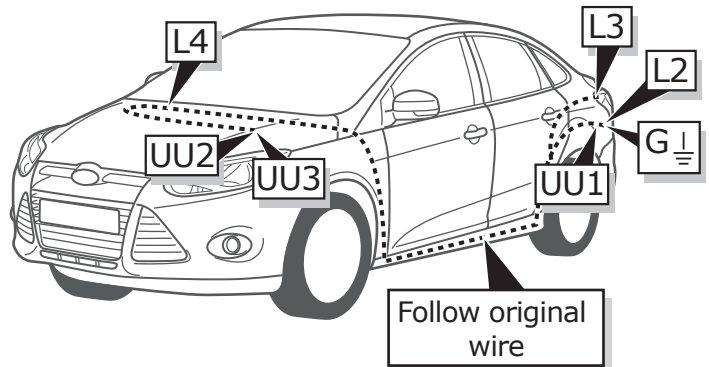

Focus Hatchback: option 1

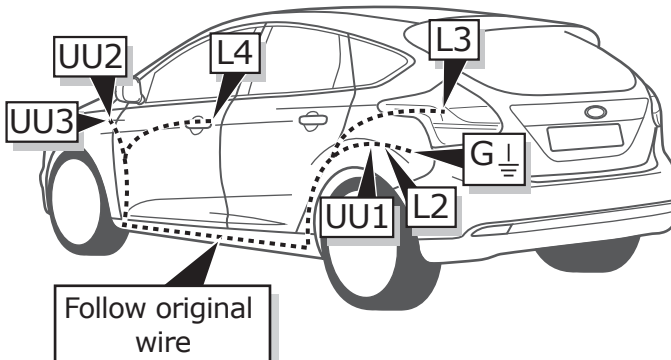

Focus Hatchback: option 2

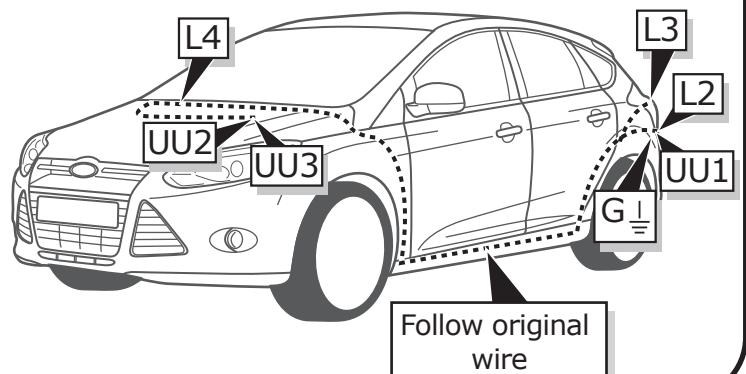

A

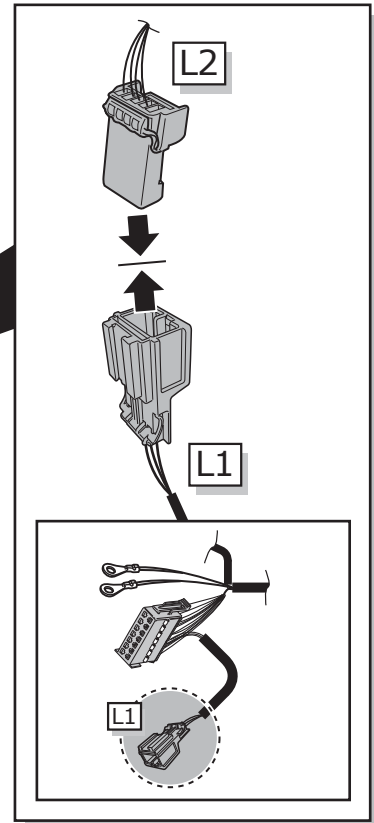
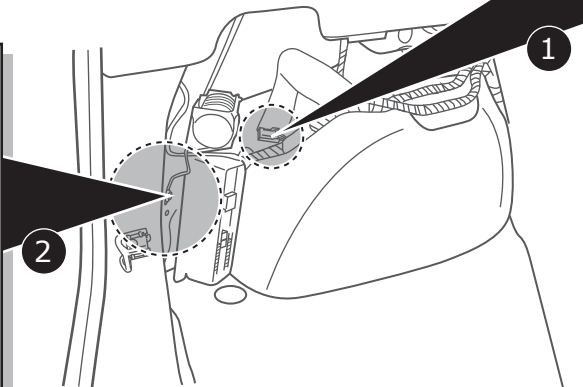
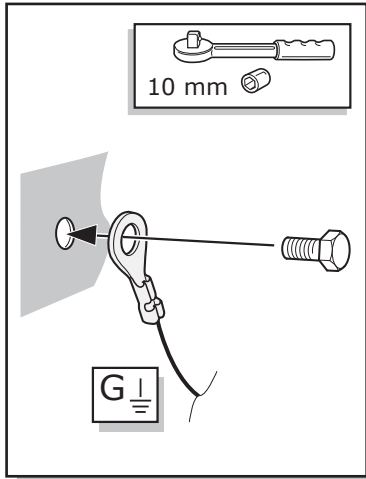
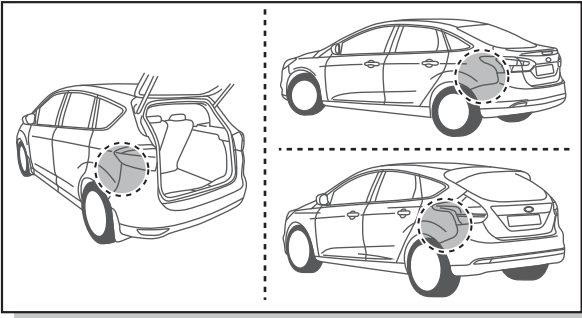

B

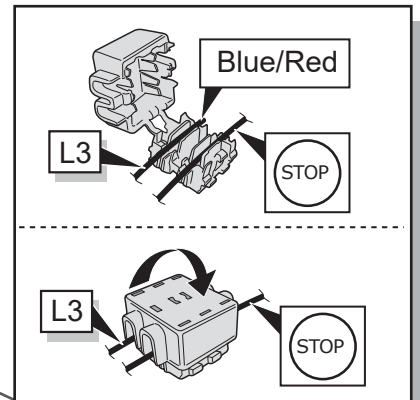
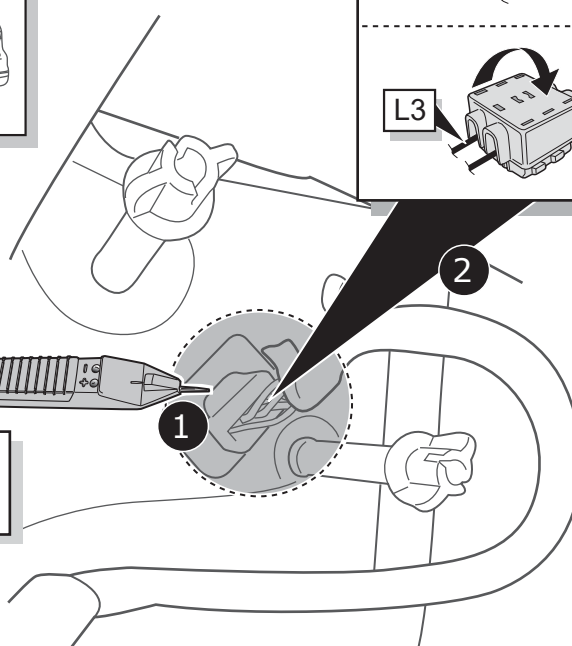
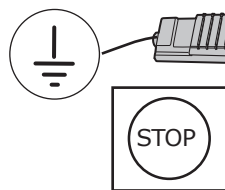
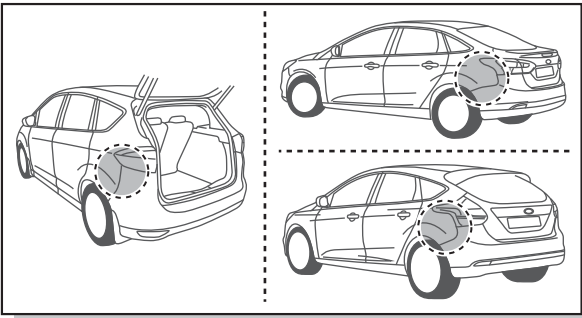



C

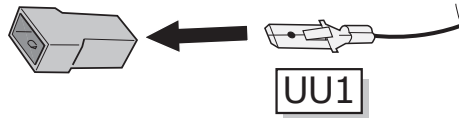
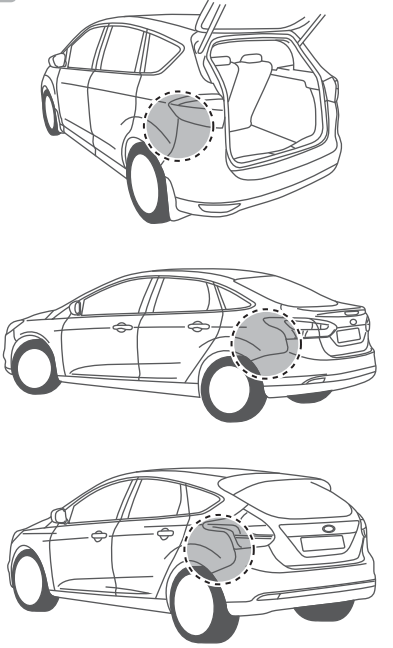

1

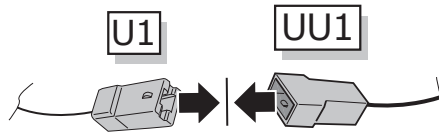

2

D

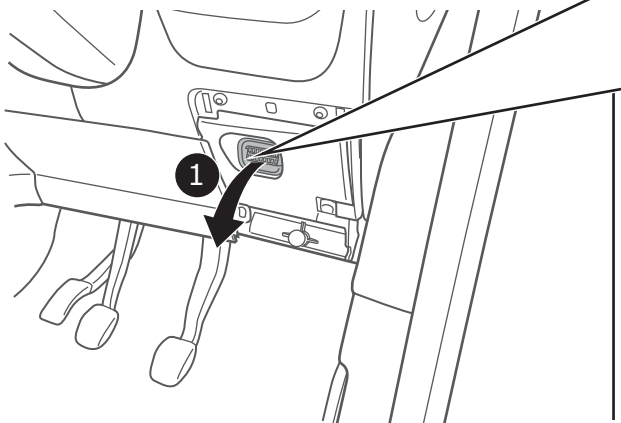
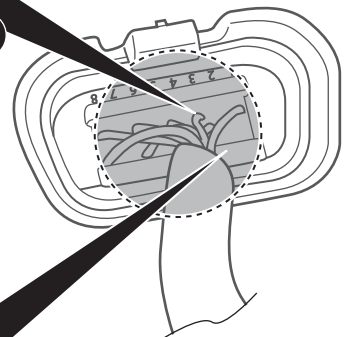
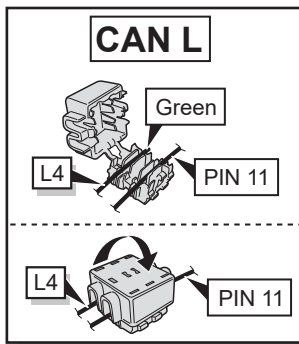
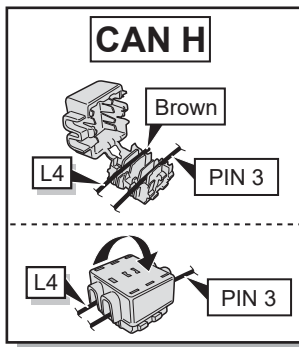
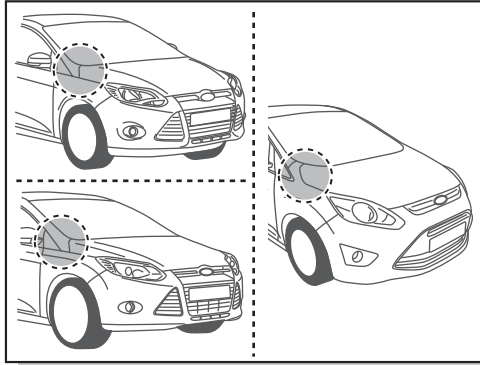

2

3



E

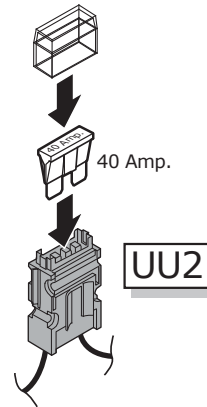
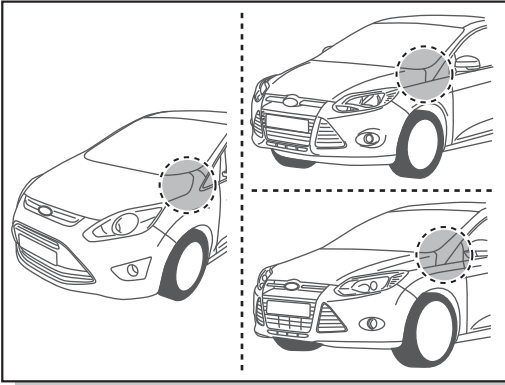

F

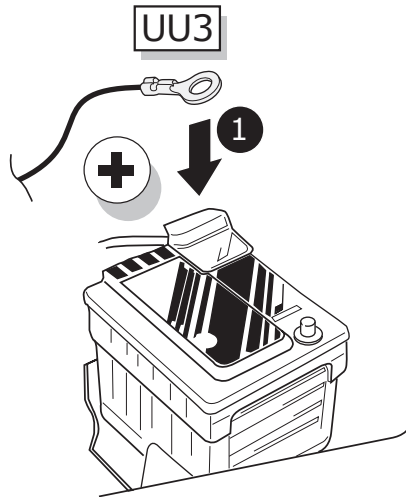

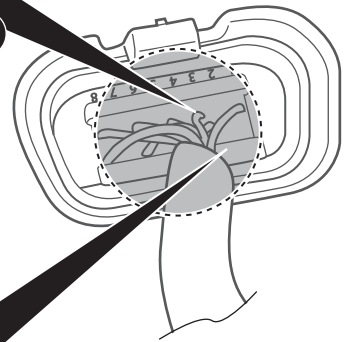
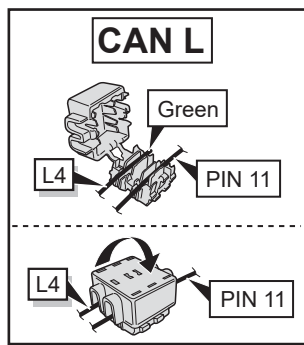
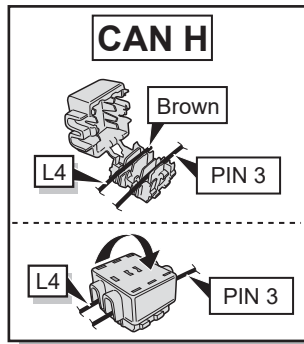
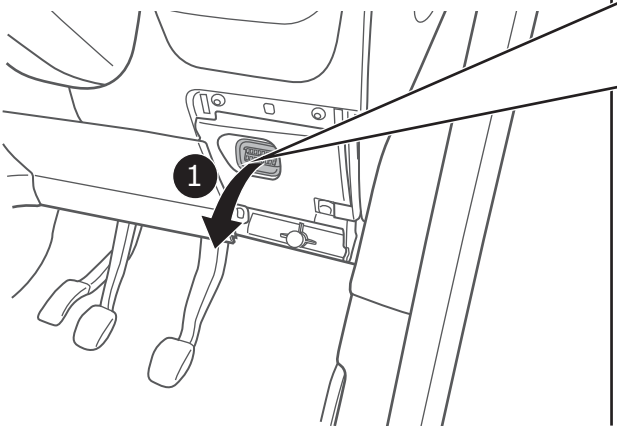
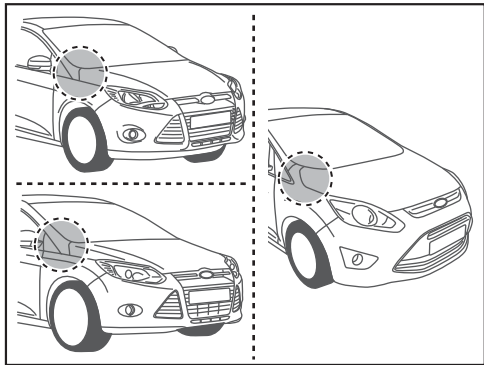
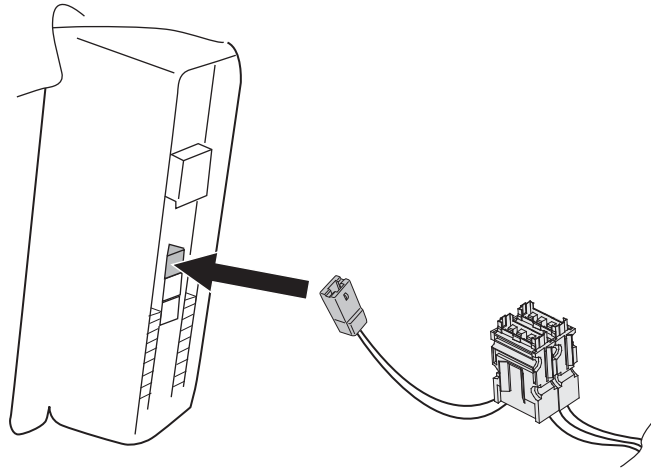
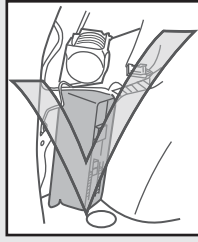

4

Pag. 9

12