

**Einbauanleitung Elektrosatz  
Anhängervorrichtung mit 12-N Steckdose  
lt. DIN/ISO Norm 1724**

**Instructions de montage du faisceau  
électrique pour crochet d'attelage  
conforme à la norme  
DIN/ISO 1724 prise 12-N**

**Fitting instructions electric wiringkit  
towbar with 12-N socket up to  
DIN/ISO norm 1724**

**Montage-handleiding elektrokabelset voor  
trekhaak met 12-N contactdoos  
vlg. DIN/ISO norm 1724**

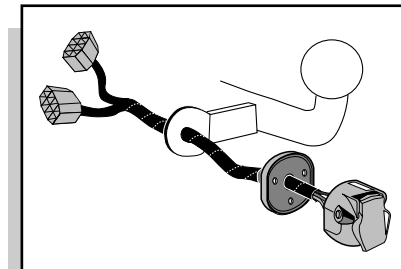

**SEAT IBIZA 1999-**

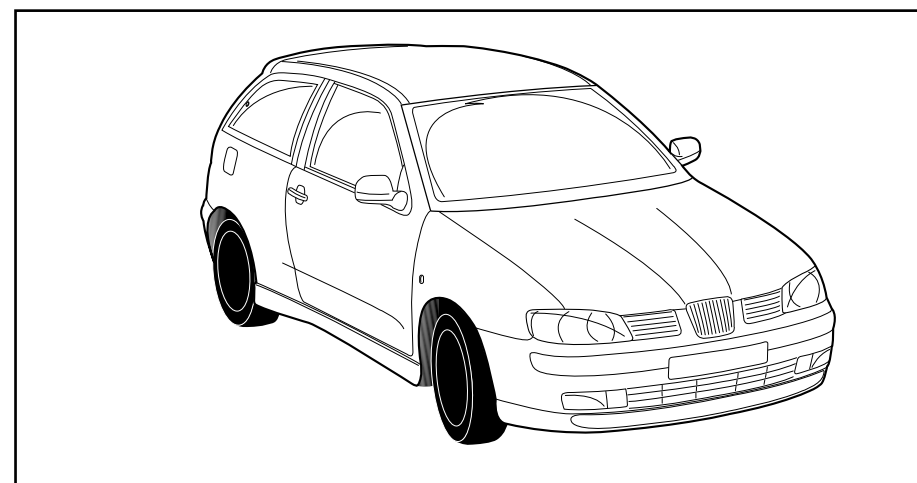

**Bestel Nr.: SE-008-BB**

\* Teilliste

\* Liste de pieces

\* Part list

\* Onderdelenlijst

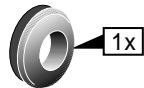
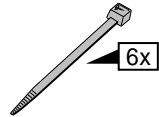
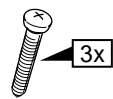
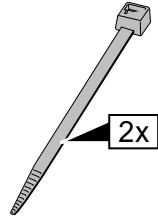
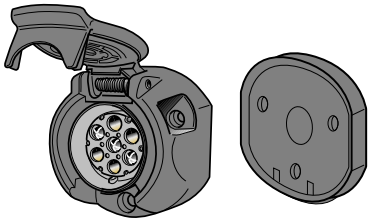
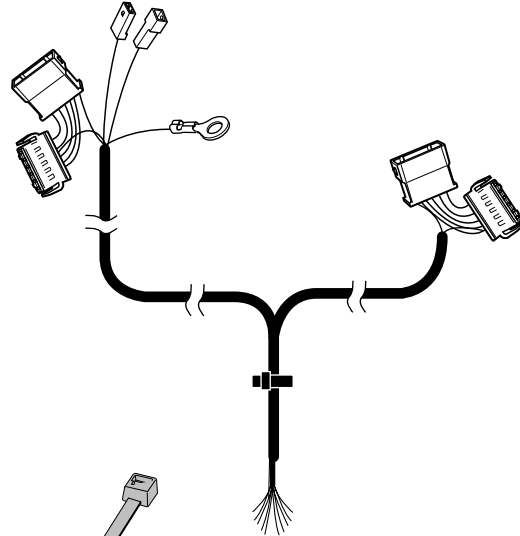
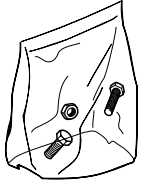
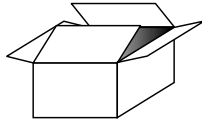

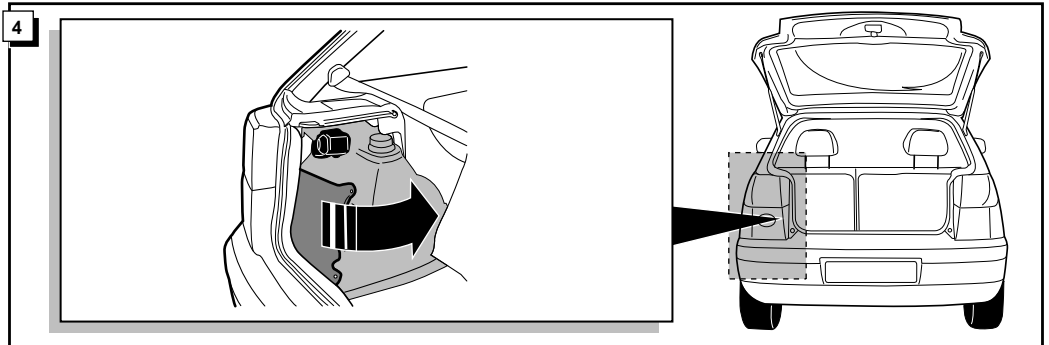
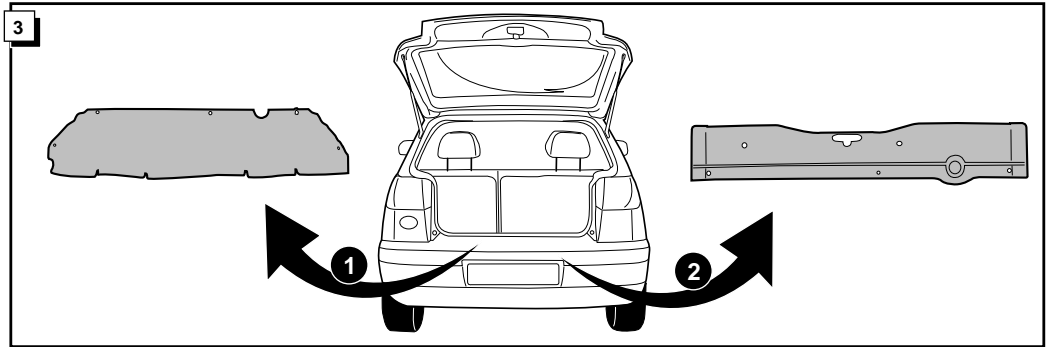
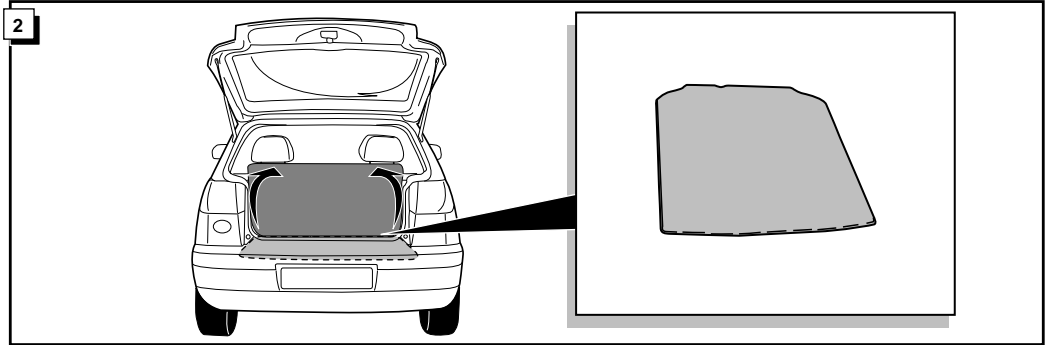
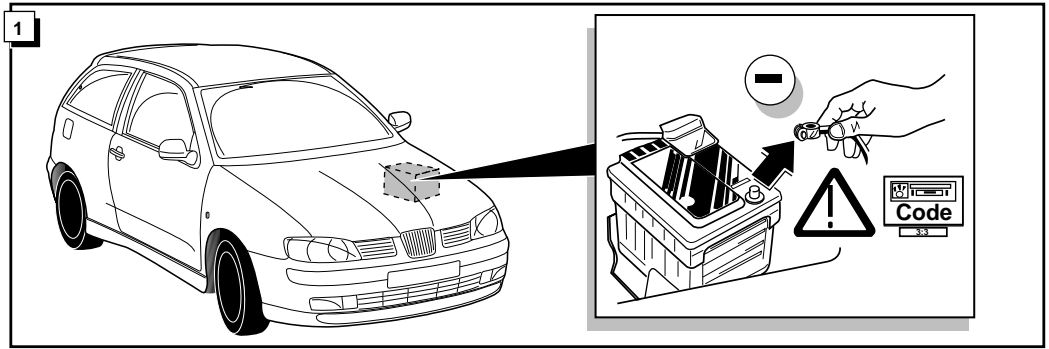

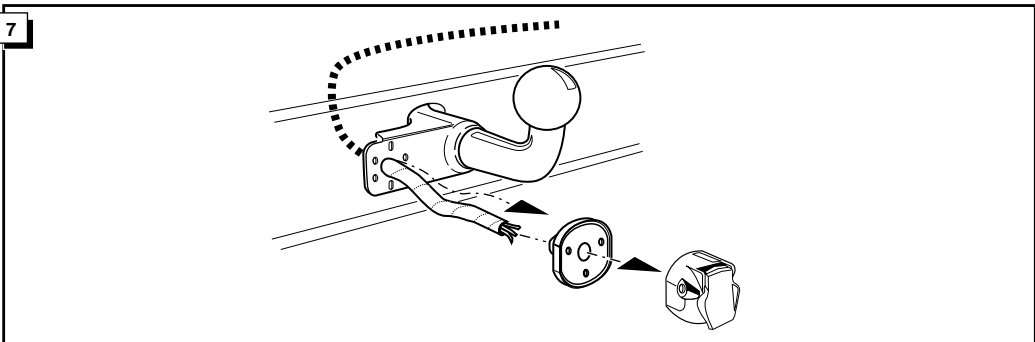
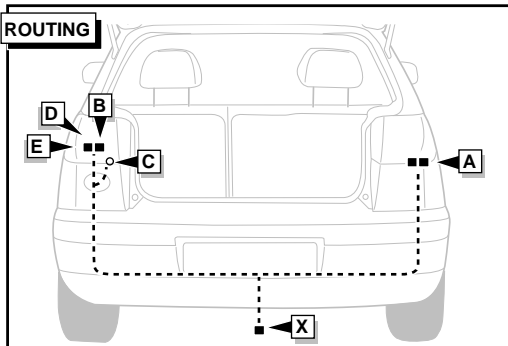
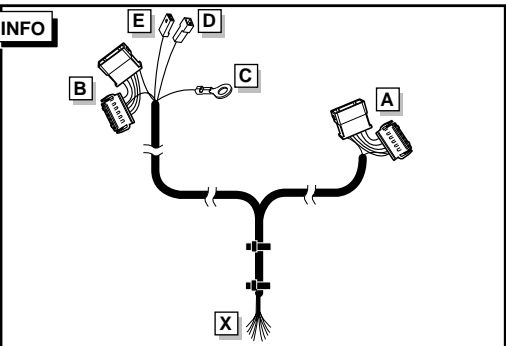
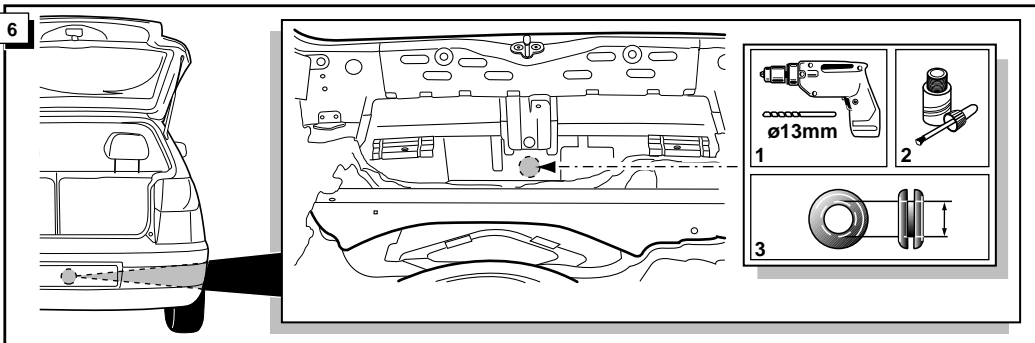
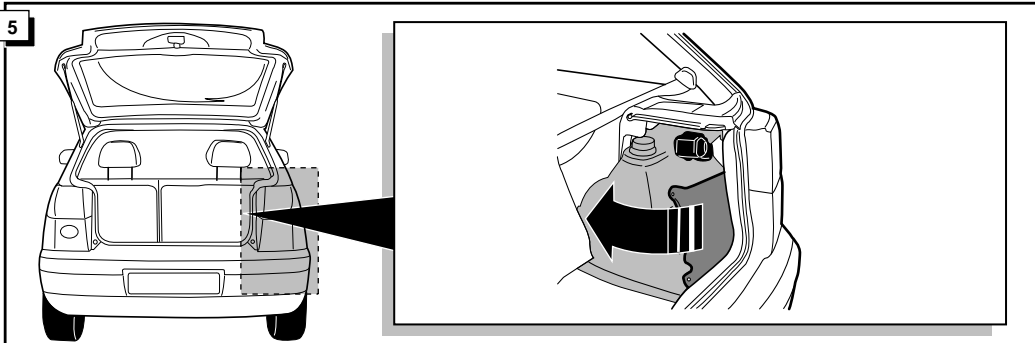

21

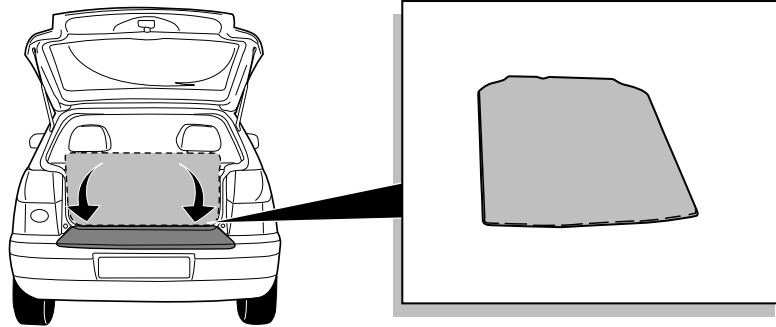

**INFO** Anschluß Steckdose / Connection de la prise / Socket connection / Contactdoos aansluiting

DIN/ISO 1724		<b>D</b>	<b>F</b>	<b>GB</b>	<b>NL</b>
↶	1/L	gelb	jaune	yellow	geel
↷	2	blau	bleu	blue	blauw
⏏	1-8	weiß	blanc	white	wit
↶	4/R	grün	vert	green	groen
☀	5/58-R	braun	marron	brown	bruin
STOP	6/54	rot	rouge	red	rood
☀	7/58-L	schwarz	noir	black	zwart
⏏ → ↶ ↷	8/58-b	grau	gris	grey	grijs

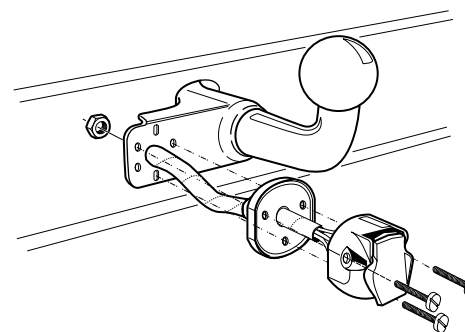
8

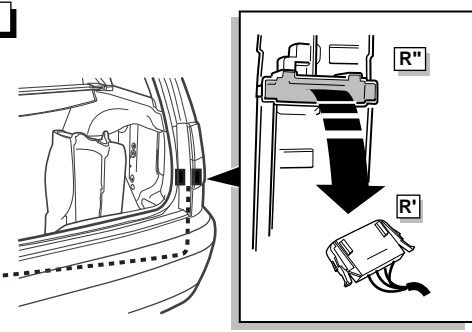

9



10

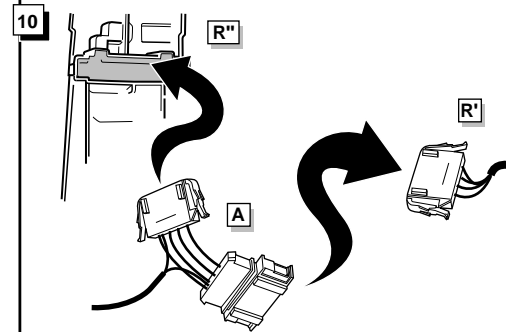

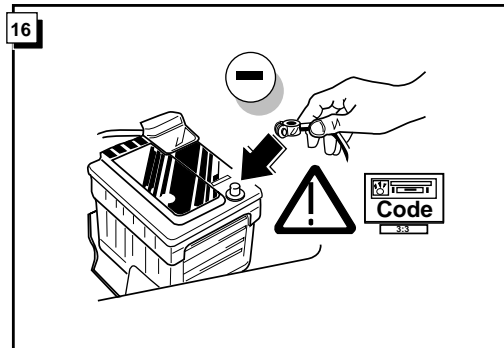
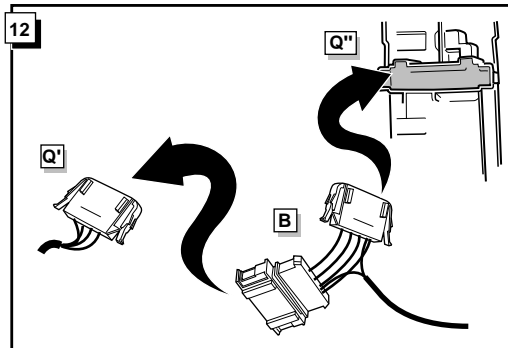
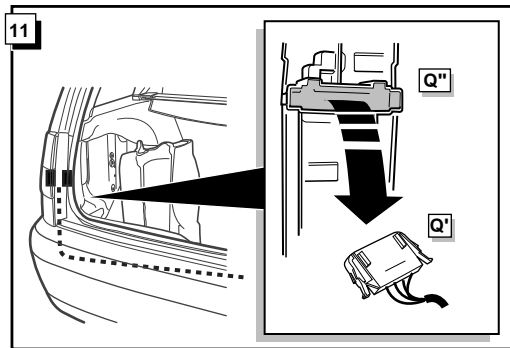

17

**! FUNKTIONEN KONTROLLIEREN !**  
**! CONTRÔLER LES FONCTIONS !**  
**! CHECK FUNCTIONS !**  
**! CONTROLEER FUNCTIES !**

