

Einbauanleitung Elektrosatz  
Anhängervorrichtung mit 12-N Steckdose  
lt. DIN/ISO Norm 1724

Instructions de montage du faisceau  
électrique pour crochet d'attelage  
conforme à la norme  
DIN/ISO 1724 prise 12-N

Fitting instructions electric wiringkit  
towbar with 12-N socket up to  
DIN/ISO norm 1724

Montage-handleiding elektrokabelset voor  
trekhaak met 12-N contactdoos  
vlgs. DIN/ISO norm 1724

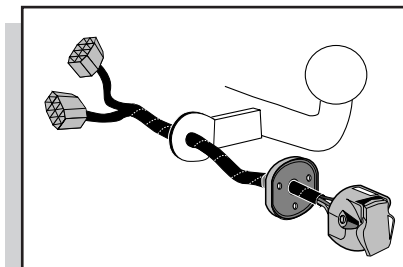

## Audi A4 1995- Without check control

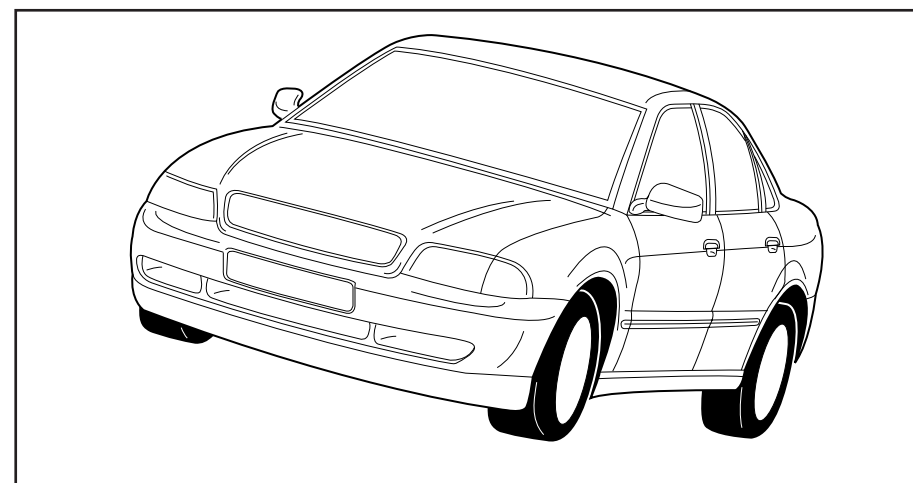

Bestel Nr.: VAG-035-B



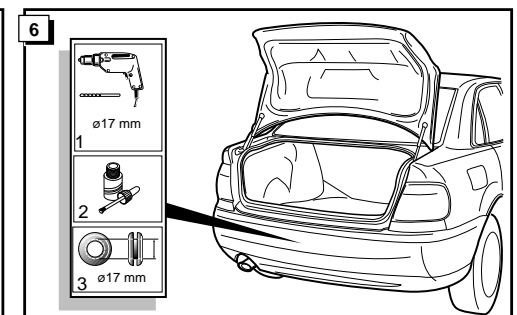
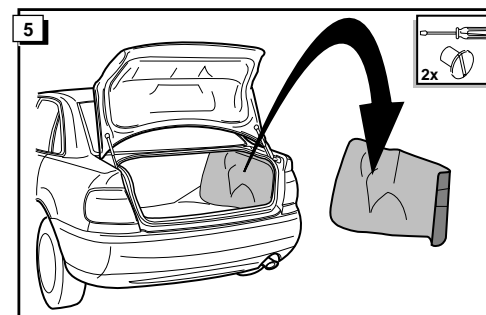
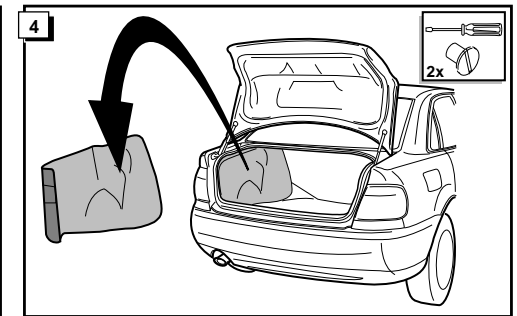
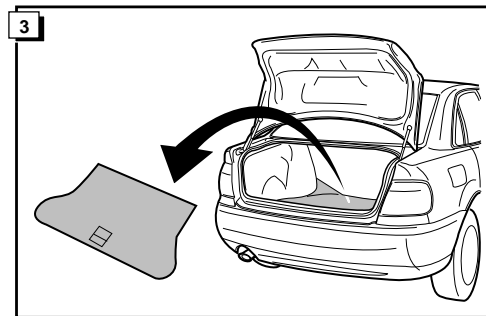
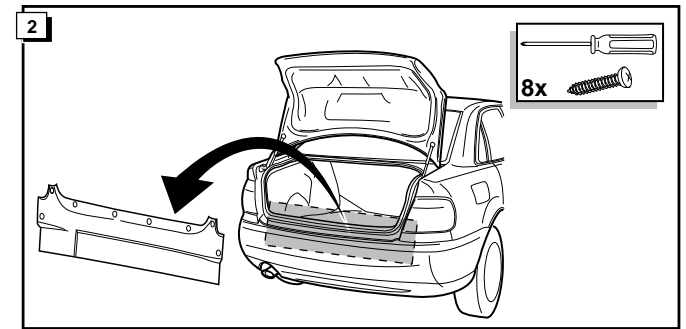
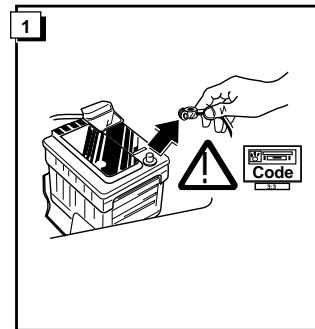
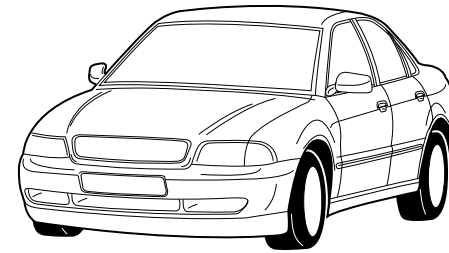

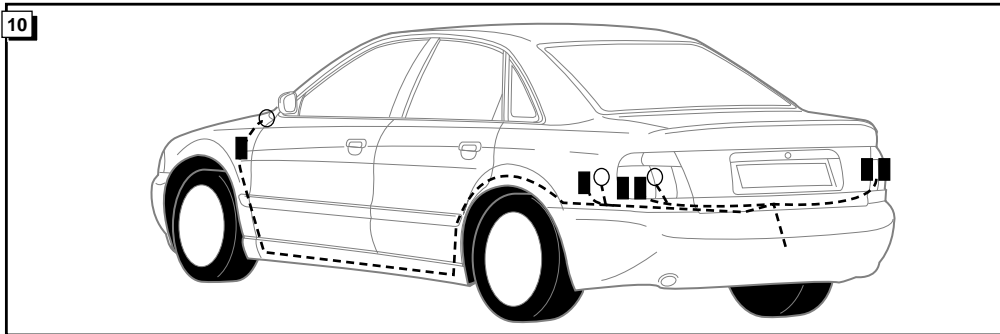
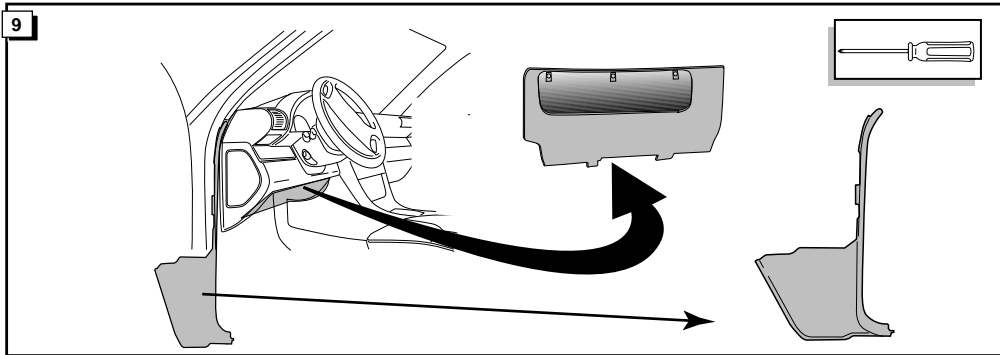
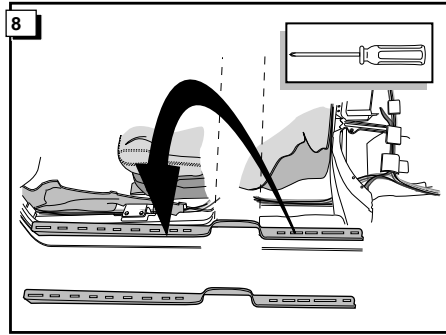
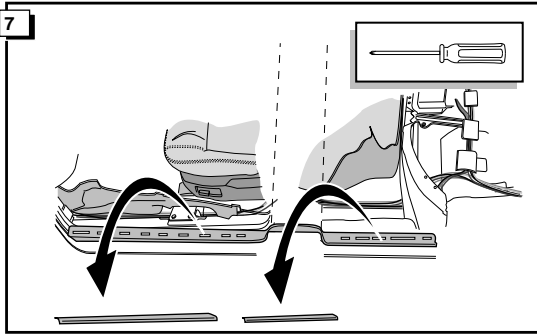

**11**

KNIPPERLICHT LINKS  
L.H. INDICATOR  
BLINKER LINKS  
CLIGNOTANT GAUCHE

REMLICHTEN  
BRAKELIGHTS  
BREMSLEUCHTE  
FEUX DE STOP

MASSA  
EARTH  
MASSE

KNIPPERLICHT RECHTS  
R.H. INDICATOR  
BLINKER RECHTS  
CLIGNOTANT DROIT

ACHERLICHT LINKS  
L.H. REARLIGHT  
SCHLÜßLEUCHTE LINKS  
FEU ARRIERE GAUCHE

ACHERLICHT RECHTS  
R.H. REARLIGHT  
SCHLÜßLEUCHTE RECHTS  
FEU ARRIERE DROIT

	NL	GB	D	FR
1 = L	GEEL	YELLOW	GELB	JAUNE
2 = 54-G	BLAUW	BLUE	BLAU	BLEU
3 = 31	WIT	WHITE	WEIß	BLANC
4 = R	GROEN	GREEN	GRÜN	VERT
5 = 58-R	BRUIN	BROWN	BRAUN	MARRON
6 = 54	ROOD	RED	ROT	ROUGE
7 = 58-L	ZWART	BLACK	SCHWARZ	NOIR
8 = 58-b	GRIJS	GREY	GRAU	GRIS

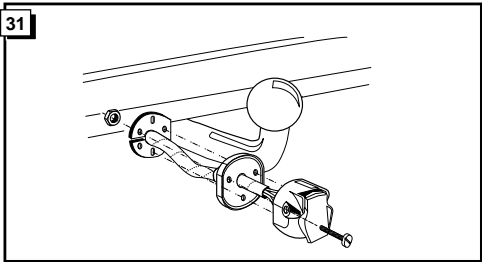
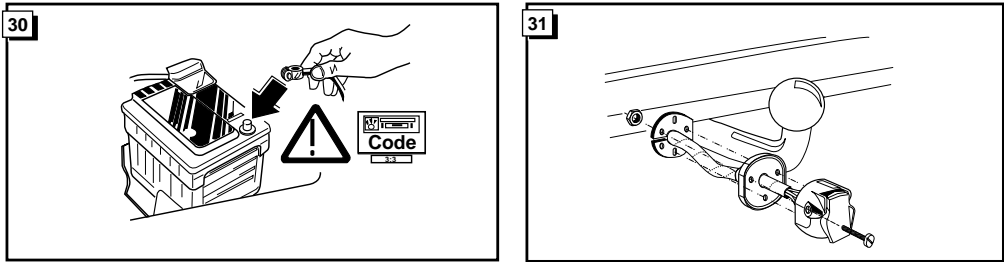

32

**!** **CONTROLEER FUNCTIES !**  
**!** **CHECK FUNCTIONS !**  
**!** **FUNKTIONEN KONTROLIEREN !**  
**!** **CONTRÔLER LES FONCTIONS !**

